

KNIGHT VALIANT





• **READ THIS FIRST** • **À LIRE EN PREMIER** • **LEER ANTES DE MONTAR**
 • **LIES DIES ZUERST** • **LEGGI PRIMA QUESTO**

ENG **BEFORE ASSEMBLING YOUR MINIATURES PLEASE READ THROUGH THE INSTRUCTIONS IN THIS BOOKLET CAREFULLY.** A pair of plastic cutters is required to remove the plastic components in this kit from their frame. We advise using a mouldline scraping tool to clean up the parts. To assemble your model you will need plastic glue. Games Workshop sells Citadel Fine Detail Cutters, Citadel Mouldline Remover and Citadel Plastic Glue, but does not recommend these products for use by children under the age of 16 without adult supervision.







FRE **AVANT D'ASSEMBLER VOS FIGURINES, VEUILLEZ LIRE ATTENTIVEMENT LES INSTRUCTIONS DE CE LIVRET.** Une pince coupante est requise pour détacher chaque élément de sa grappe. Nous vous recommandons l'utilisation d'un grattoir pour ébarber les éléments. Pour l'assemblage, vous aurez également besoin de colle plastique. Games Workshop commercialise les Pinces de Précision Citadel, l'Ébarboir Citadel et la Colle Plastique Citadel, mais n'en recommande pas l'utilisation pour des enfants de moins de 16 ans sans la supervision d'un adulte.

SPA **POR FAVOR, LEE CUIDADOSAMENTE ESTE LIBRETO DE INSTRUCCIONES ANTES DE EMPEZAR A MONTAR LAS MINIATURAS.** Te harán falta unas tenazas para plástico a fin de separar las piezas de la matriz. También aconsejamos una herramienta para rebabas a fin de limpiar cada pieza. Para montar la miniatura necesitarás pegamento para plástico. Games Workshop vende Tenazas Citadel, Herramientas para rebabas Citadel y Pegamento para plástico Citadel, pero no recomienda estos productos a menores de 16 años sin la supervisión de un adulto.

GER **VOR DEM ZUSAMMENBAU DER MINIATUREN BITTE DIE ANWEISUNGEN IN DIESER ANLEITUNG AUFMERKSAM DURCHLESEN.** Du benötigst einen Kunststoffseitenschneider, um die Kunststoffbauteile aus dem Gussrahmen herauszutrennen, und Kunststoffkleber, um die Miniatur zusammenzubauen. Außerdem empfehlen wir, die Bauteile vorher mit einem Gussgratentferner zu säubern. Games Workshop bietet Präzisions-Kunststoffseitenschneider von Citadel sowie Citadel-Kunststoffkleber an, empfiehlt aber, dass Kinder unter 16 Jahren diese nur unter Aufsicht eines Erwachsenen benutzen.

ITA **PRIMA DI ASSEMBLARE LE TUE MINIATURE LEGGI ATTENTAMENTE TUTTE LE ISTRUZIONI DI QUESTO LIBRETTO.** Sono necessarie un paio di tronchesine per plastica per staccare i componenti dai loro sprue. Consigliamo di usare un attrezzo apposito per pulire i componenti. Per assemblare il modello avrai bisogno di colla per plastica. Games Workshop vende Tronchesine di precisione Citadel, Attrezzo per ripulire Citadel e Colla per plastica Citadel, ma non consiglia questi prodotti ad un pubblico minore di 16 anni senza la supervisione di un adulto.

• **EXPLANATION OF SYMBOLS** • **EXPLICATION DES SYMBOLES** • **EXPLICACIÓN DE SÍMBOLOS**
 • **ERLÄUTERUNG DER SYMBOLE** • **LEGENDA DEI SIMBOLI**

- | | | |
|--|--|---|
|  <ul style="list-style-type: none"> • Special instruction - Please read • Instructions spéciales - Lire attentivement • Instrucción especial: Por favor, léela • Besondere Anweisung - Bitte lesen • Istruzioni speciali - Leggi attentamente |  <ul style="list-style-type: none"> • Choice of parts • Choix d'éléments • Modelos de componentes • Auswahl an Teilen • Scelta di componenti |  <ul style="list-style-type: none"> • Variant assembly • Variante d'assemblage • Variante de montage • Bauvariante • Assemblaggio alternativo |
|  <ul style="list-style-type: none"> • Dry fit stage before gluing • Tester avant de coller • Comprobar el encaje antes de pegar • Positionierung erst ohne Klebstoff ausprobieren • Prova a secco prima di incollare |  <ul style="list-style-type: none"> • Do not glue the components • Ne pas coller les éléments • No pegar los componentes • Bitte die Teile nicht kleben • Non incollare i componenti |  <ul style="list-style-type: none"> • Repeat process • Répéter l'étape • Repetir pasos • Vorgang wiederholen • Ripeti il processo |

16+



- Citadel plastic glue
- Colle plastique Citadel
- Pegamento para plástico
- Citadel-Kunststoffkleber
- Colla per plastica Citadel



- Citadel fine detail cutters
- Pinces de précision Citadel
- Tenazas Citadel
- Citadel-Seitenschneider
- Tronchesine di precisione Citadel



- Citadel mouldline remover
- Ébarboir Citadel
- Herramienta para rebabas Citadel
- Gussgratentferner
- Attrezzo per ripulire Citadel

1 a

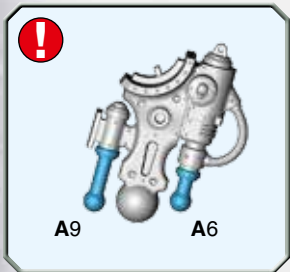
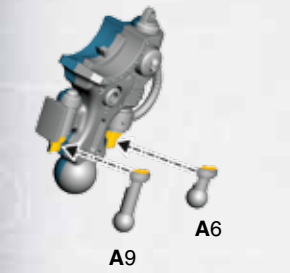
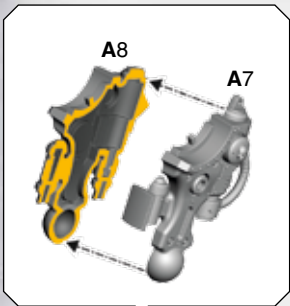

1 b

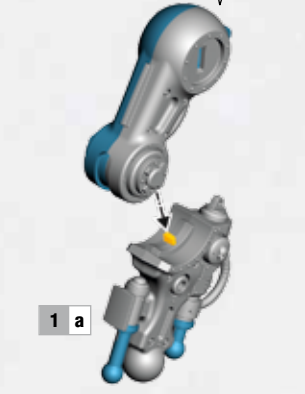
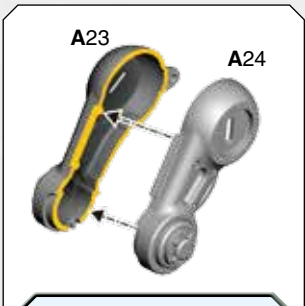

1 c

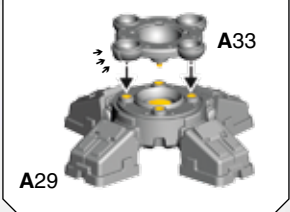
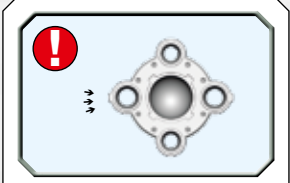
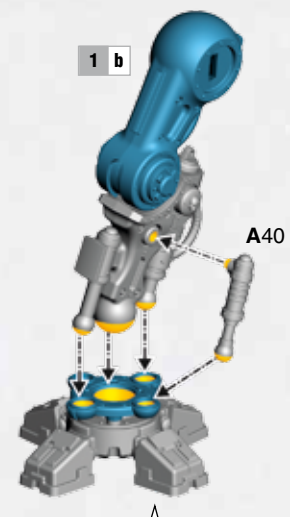

1 d

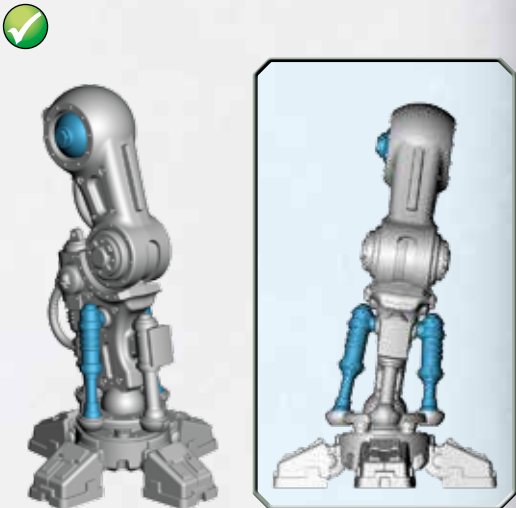
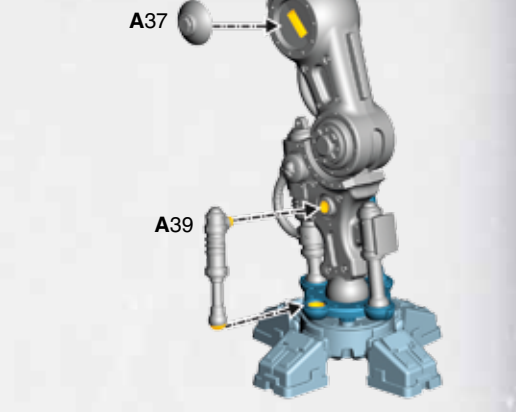

2 a

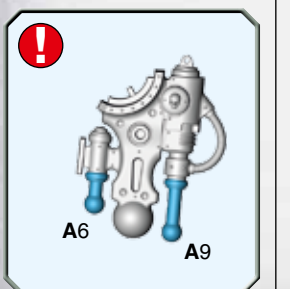
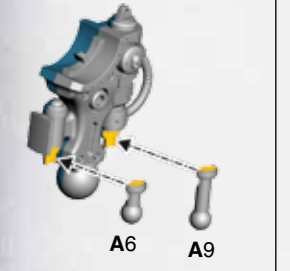
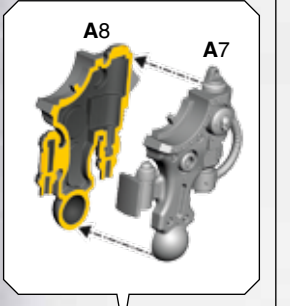

2 b

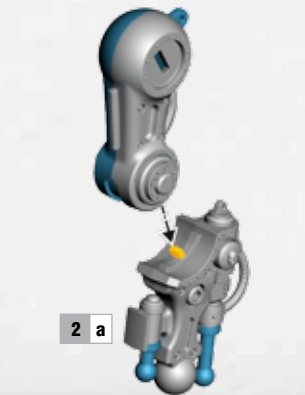
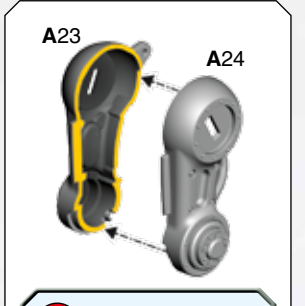

2 c

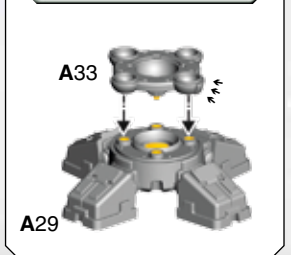
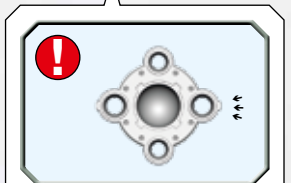
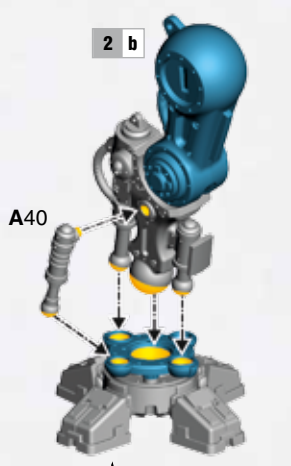

2 d

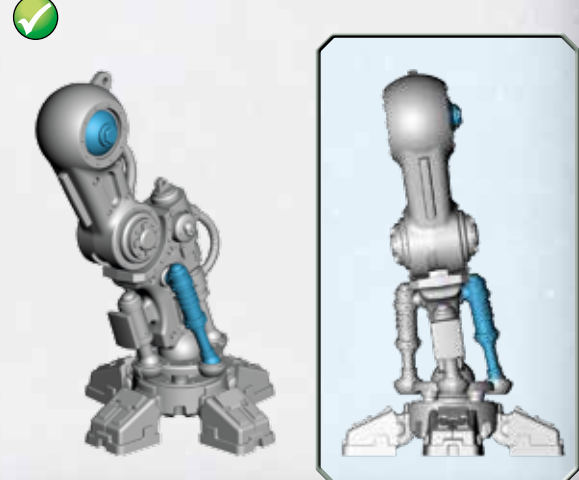
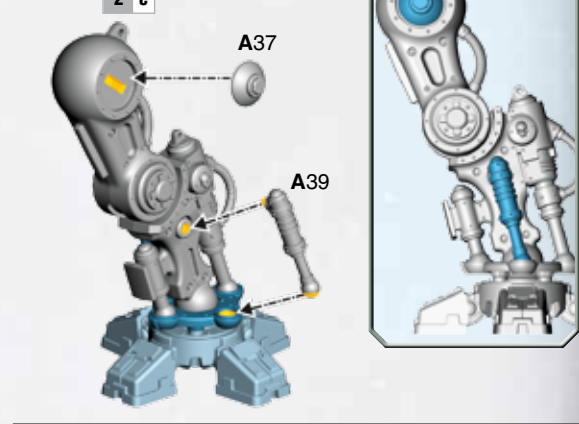

3 a

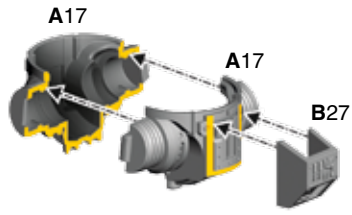

3 b

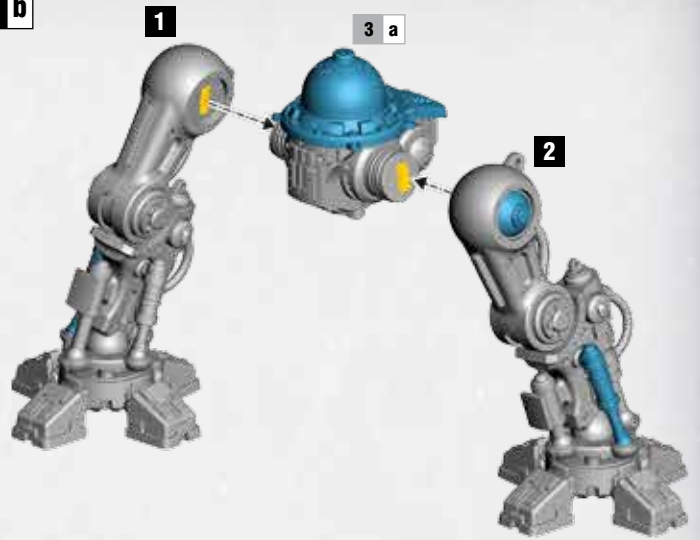

3 c

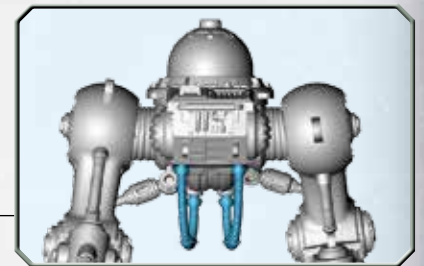
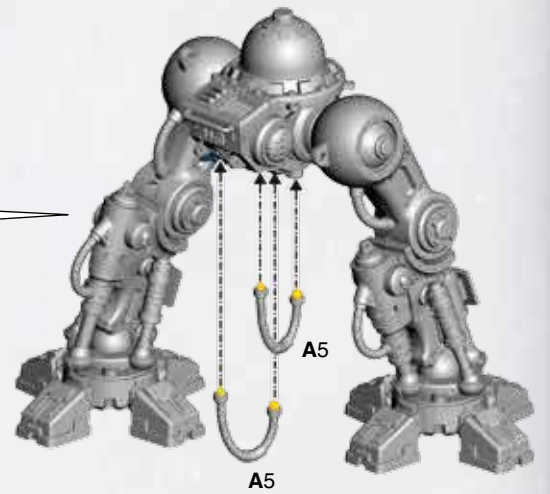
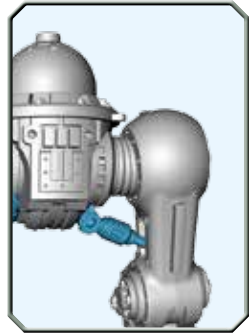
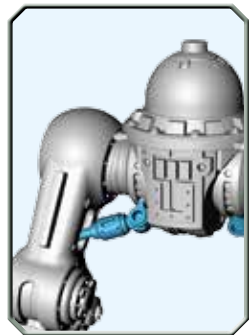
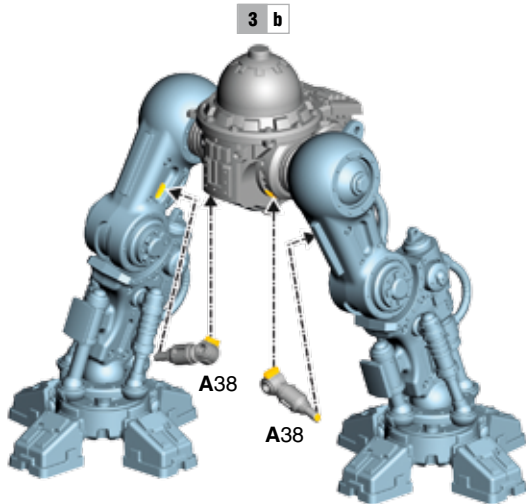

3 d

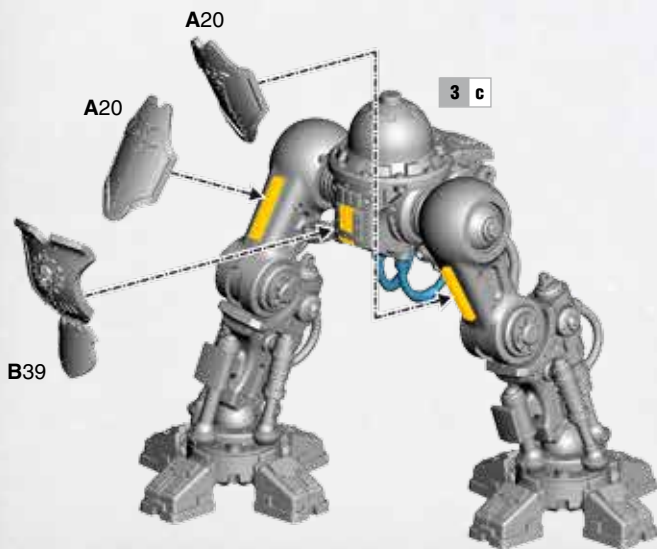

6 a x2

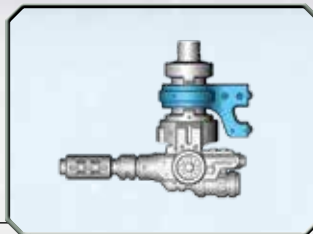
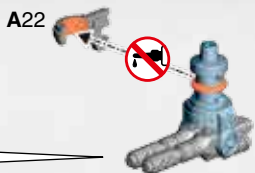
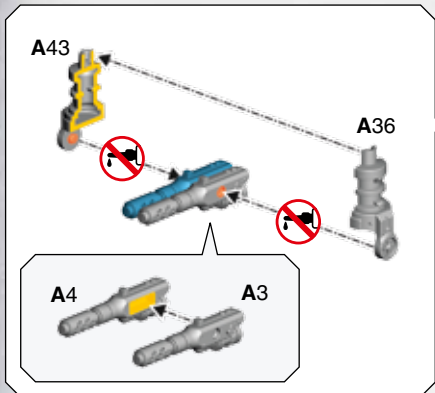

- Twin meltagun
- Fuseur jumelé
- Rifle de fusión doble
- Zwillingsmelter
- Doppio fucile termico

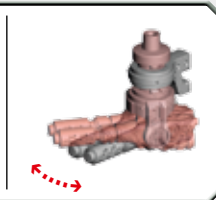
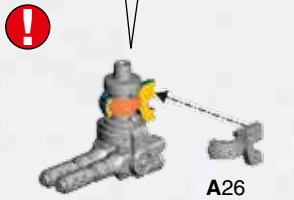

6 b

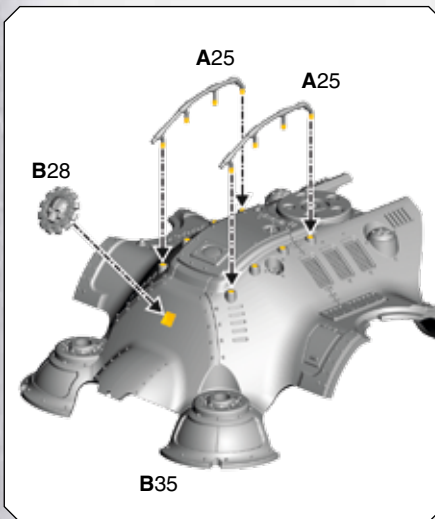

6 c !

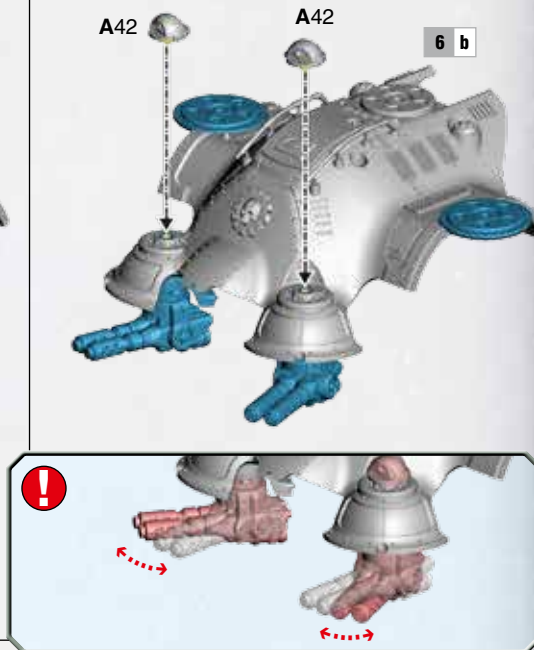

6 d !

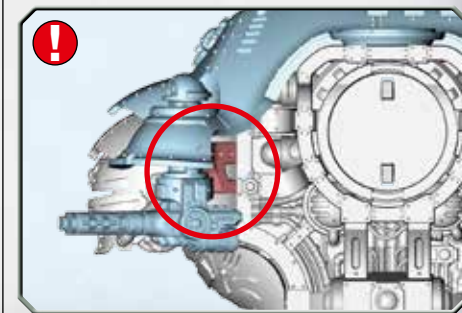
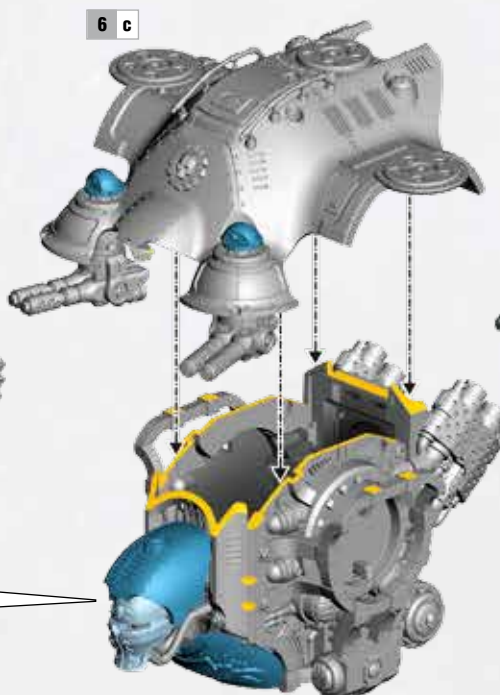
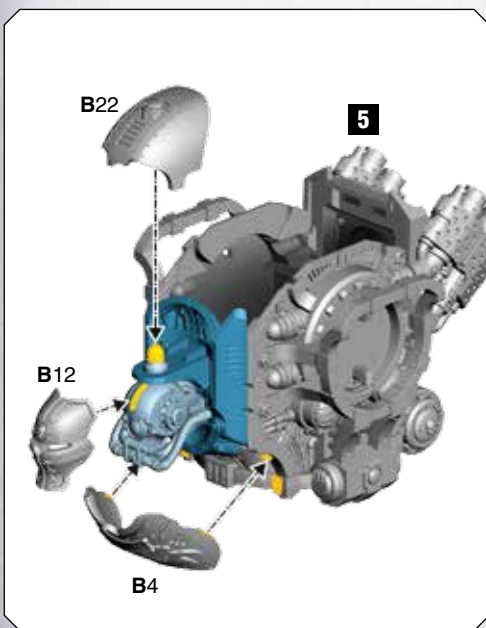

7 a THUNDERCOIL HARPOON

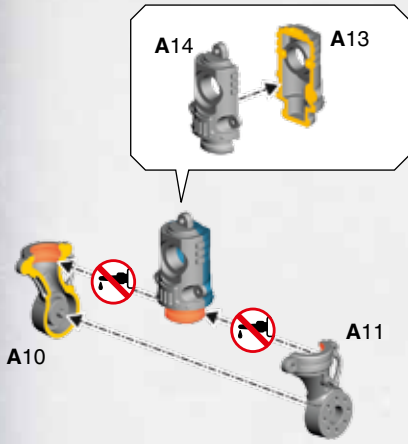

7 b

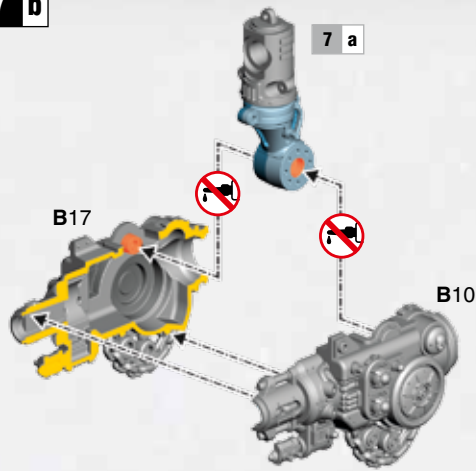

7 c

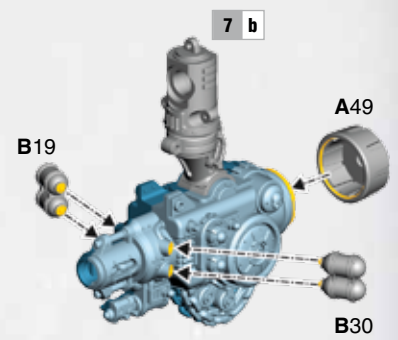

7 d

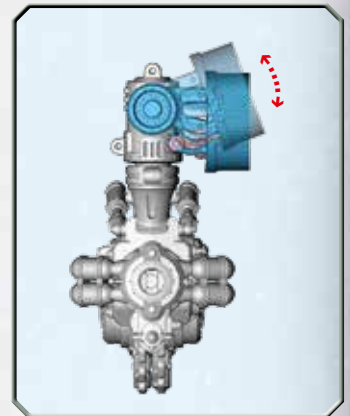
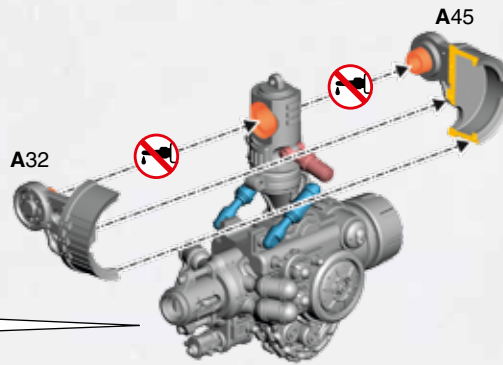
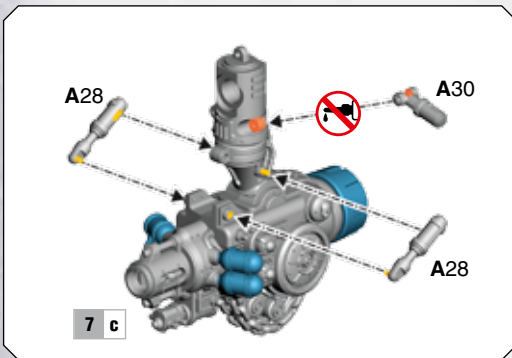

7 e

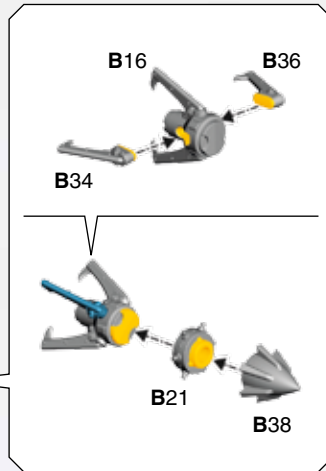
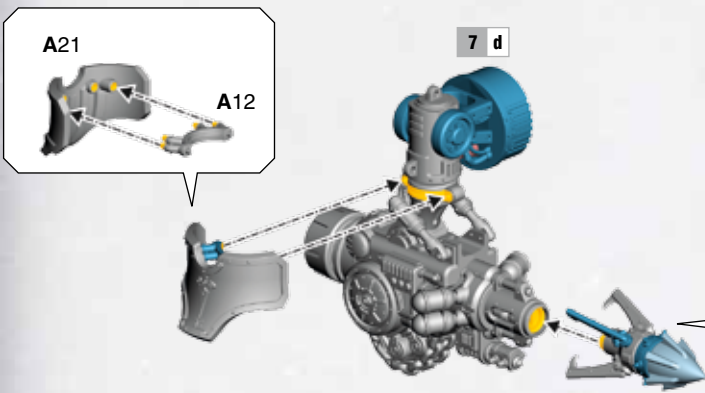

- Thundercoil harpoon
- Harpon Thundercoil
- Arpón espiral de trueno
- Donnerspulenharpune
- Arpione thundercoil

8 a CONFLAGRATION CANNON

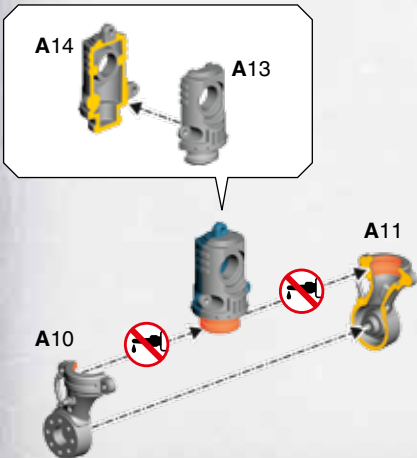

8 b

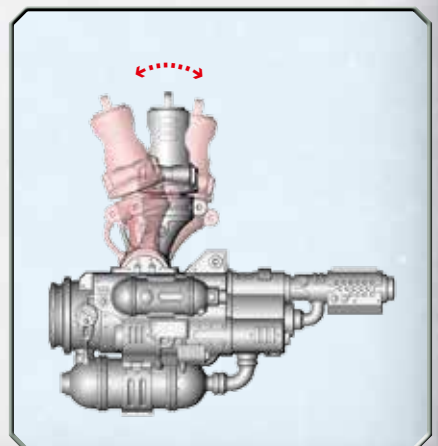
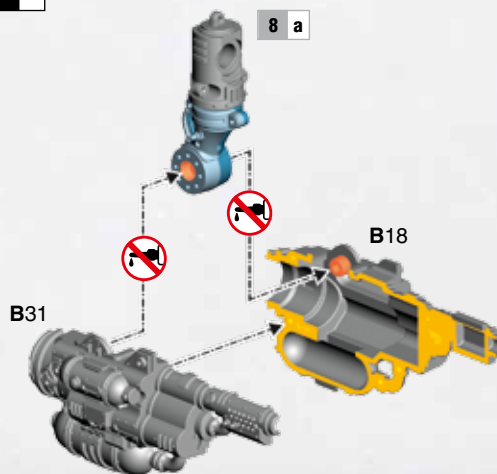

8 c

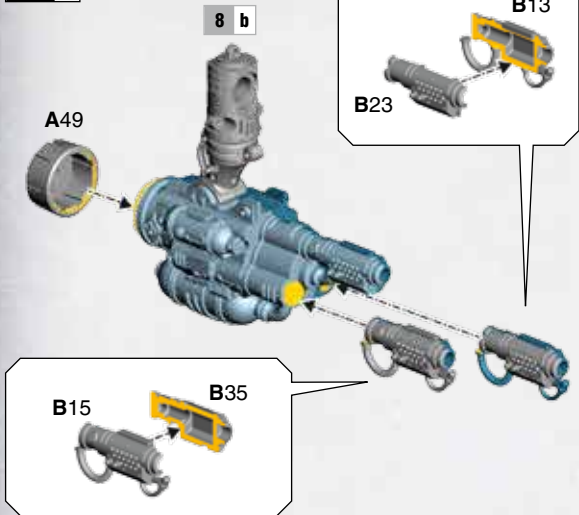

8 d

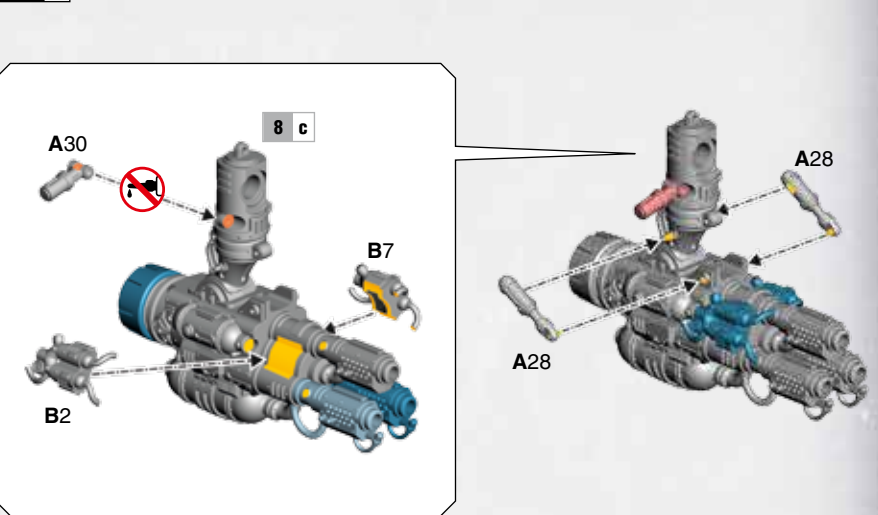

8 e

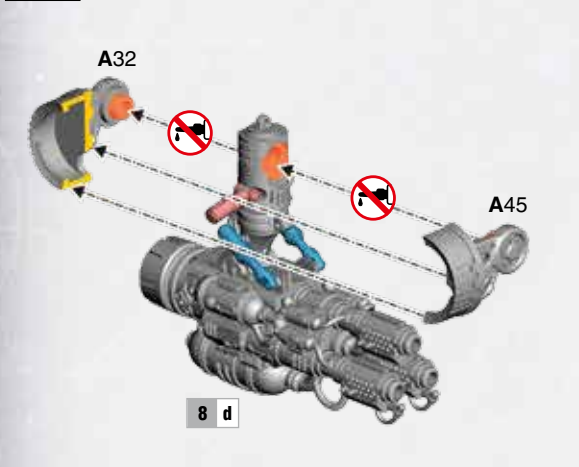

8 f

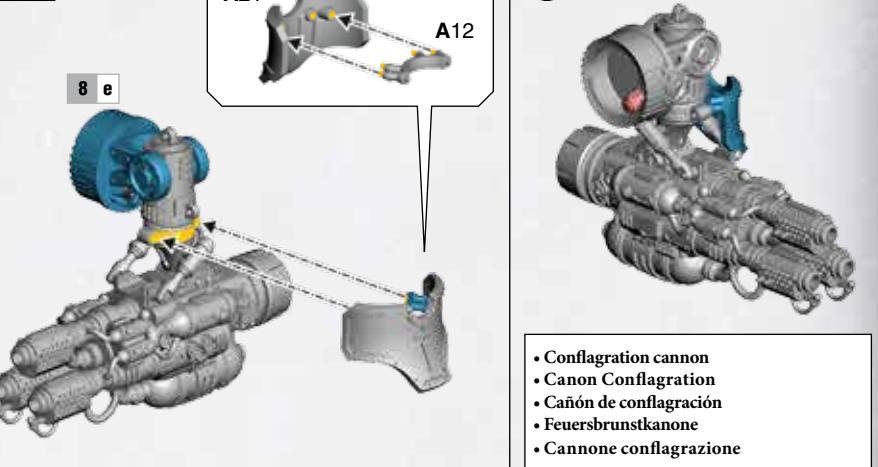

9 a

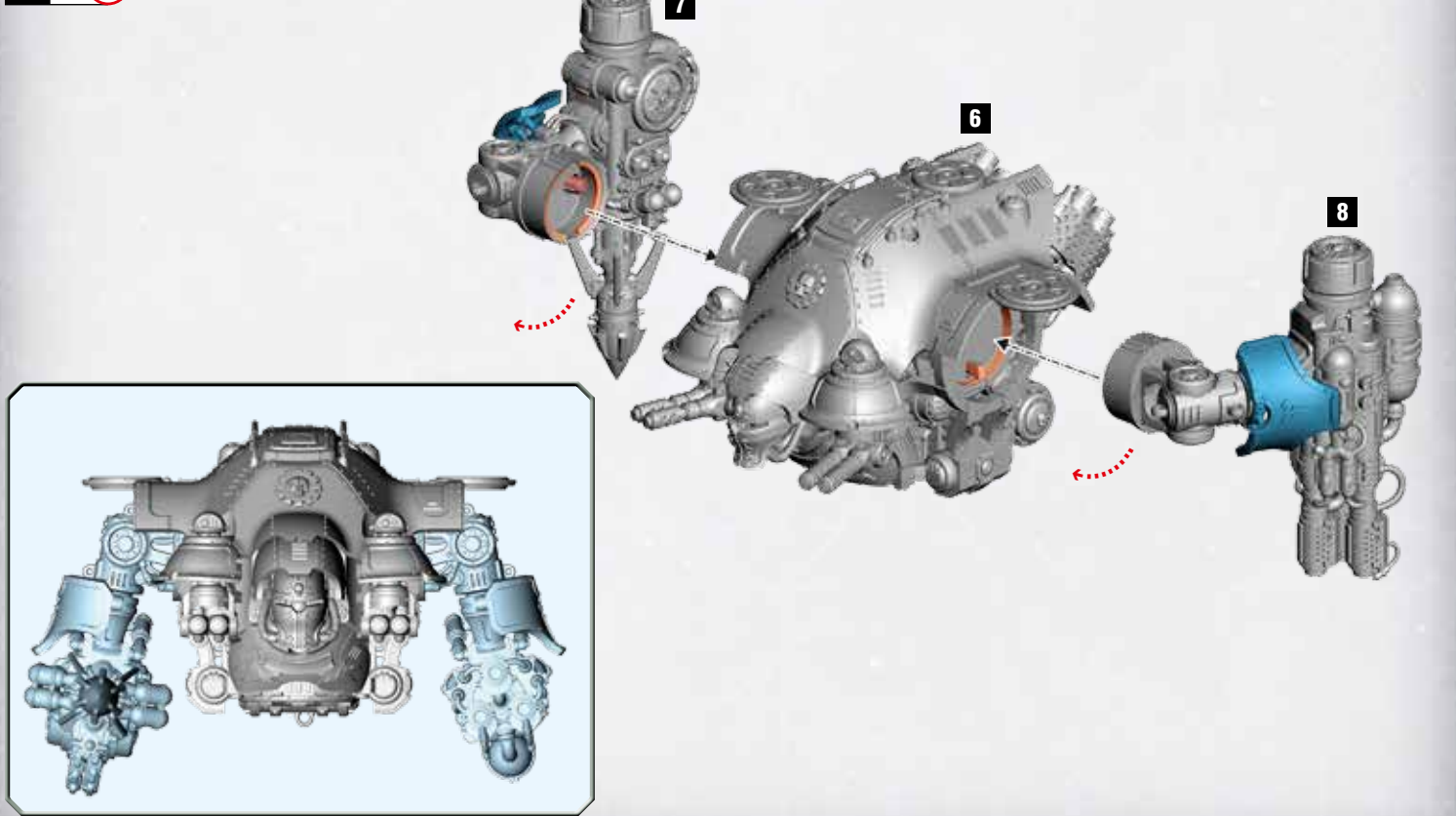

9 b 

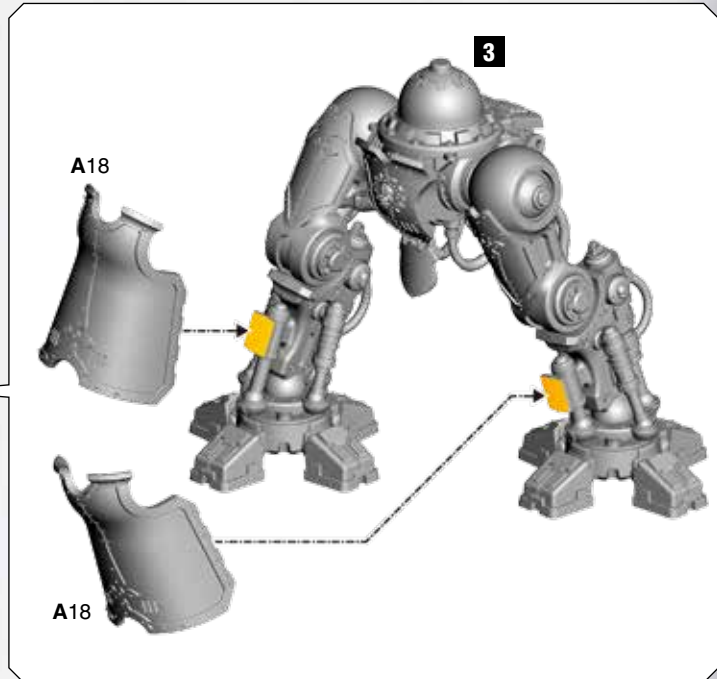
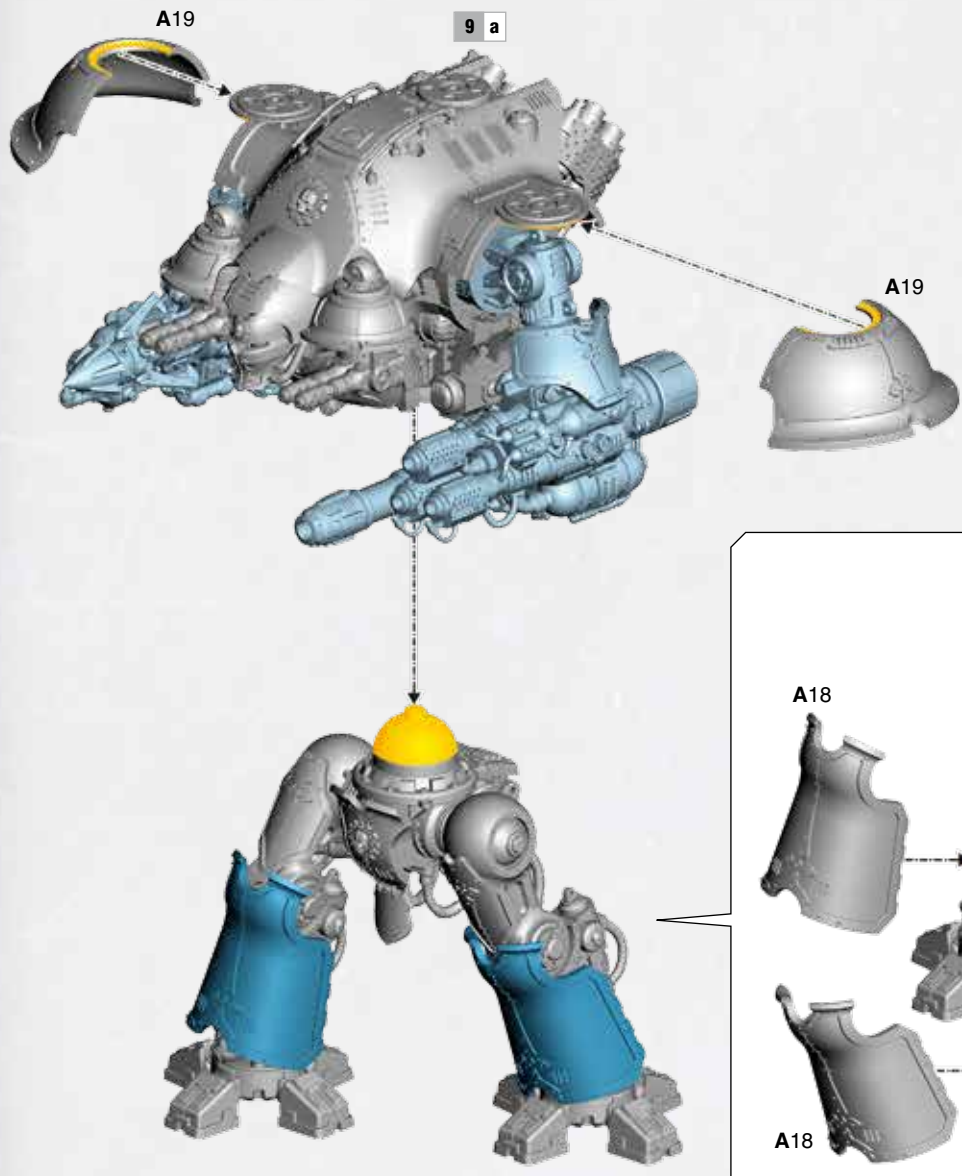

9 c 

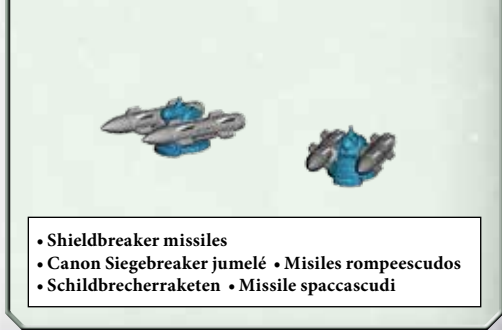
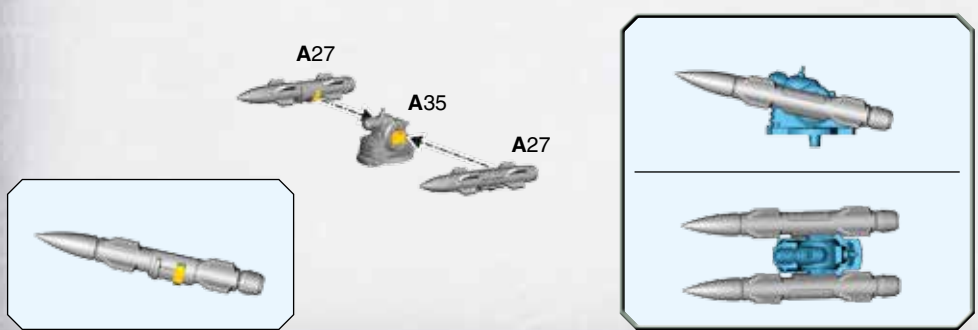
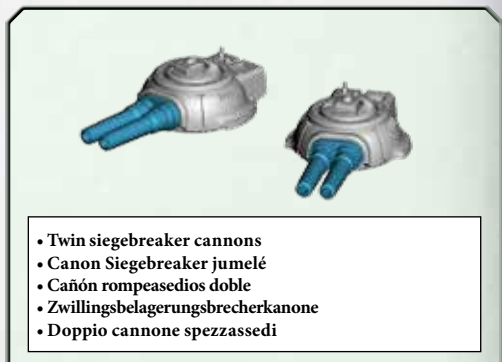
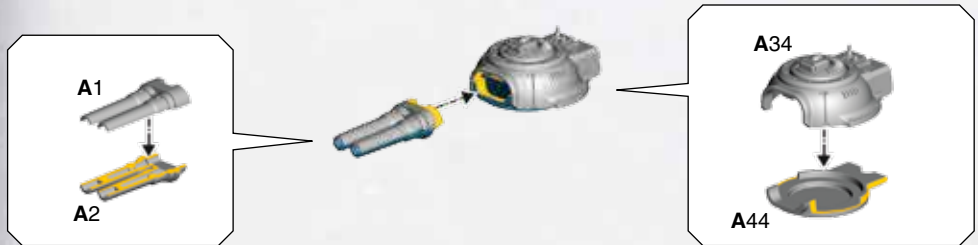

9 d

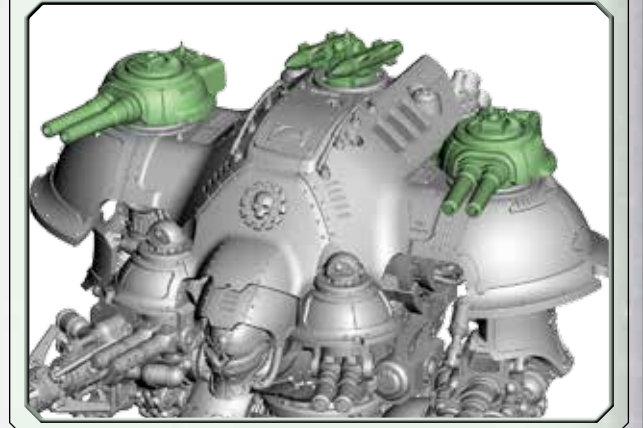
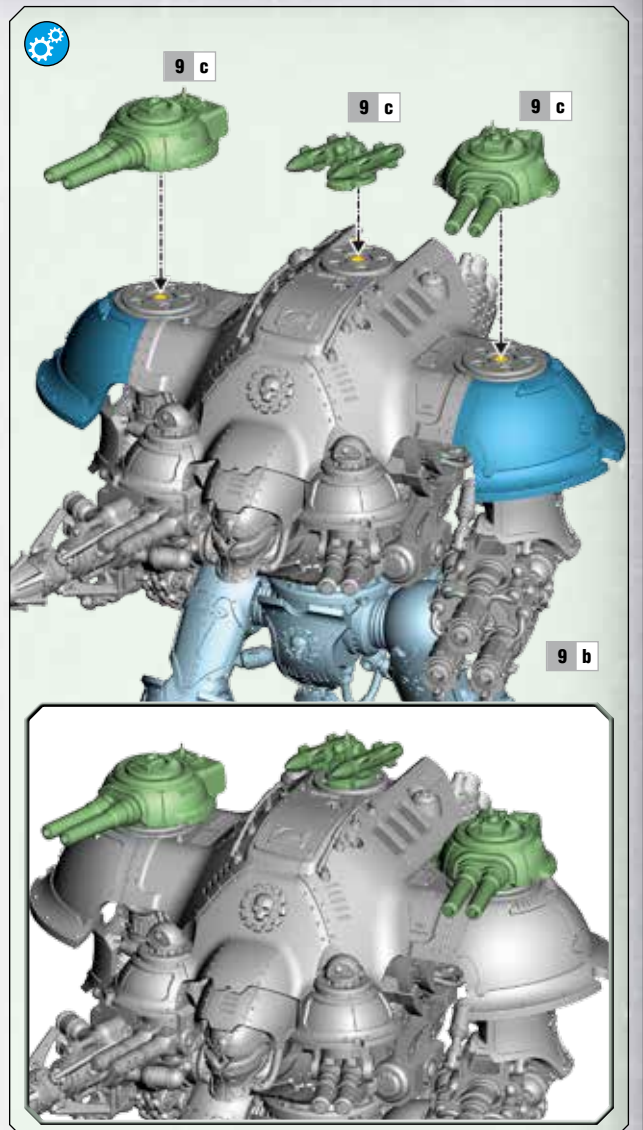
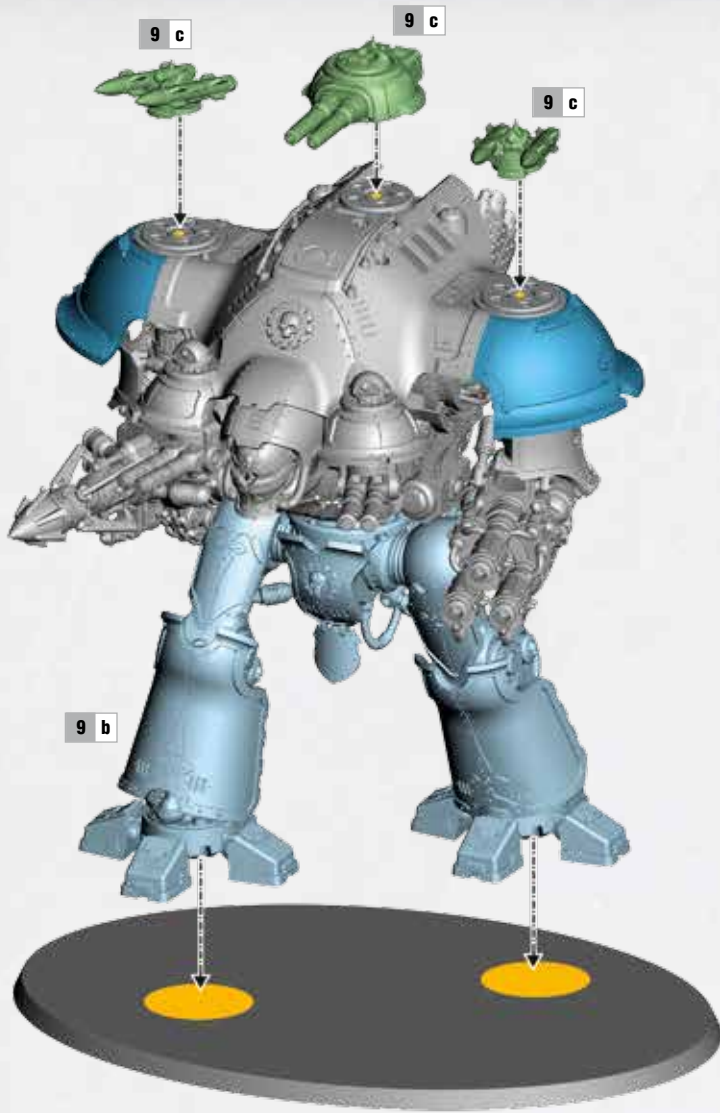

These essential rules will get your new unit on the battlefield – for the full rules for this unit, see the Codex or Index book relevant to your army.

KNIGHT VALIANT

30
POWER

NAME	M	WS	BS	S	T	W	A	Ld	Sv
Knight Valiant	*	*	*	8	8	28	4	9	3+

A Knight Valiant is a single model equipped with a thundercoil harpoon, conflagration cannon, twin siegebreaker cannon, two twin meltaguns, four shieldbreaker missiles and titanic feet.

DAMAGE

Some of this model's characteristics change as it suffers damage, as shown below:

REMAINING W	M	WS	BS
15-28+	10"	4+	3+
8-14	7"	5+	4+
1-7	4"	6+	5+

WEAPONS	RANGE	TYPE	S	AP	D	ABILITIES
Conflagration cannon	18"	Heavy 3D6	7	-2	2	This weapon automatically hits its target.
Shieldbreaker missile	48"	Heavy 1	10	-4	D6	Each shieldbreaker missile can only be fired once per battle, and a model can only fire one each turn. Invulnerable saving throws cannot be made against wounds caused by this weapon.
Twin siegebreaker cannon	48"	Heavy 2D3	7	-1	D3	-
Thundercoil harpoon	12"	Heavy 1	16	-6	10	You can re-roll failed hit rolls when targeting VEHICLE or MONSTER units with this weapon. In addition, if this weapon inflicts any damage, the target unit suffers an additional D3 mortal wounds.
Twin meltagun	12"	Assault 2	8	-4	D6	If the target is within half range of this weapon, roll two dice when inflicting damage with it and discard the lowest result.
Titanic feet	Melee	Melee	User	-2	D3	Make 3 hit rolls for each attack made with this weapon.

WARGEAR OPTIONS

- This model may replace two of its shieldbreaker missiles with a twin siegebreaker cannon.

ABILITIES

Ion Shield: This model has a 5+ invulnerable save against ranged weapons.

Dual Plasma Core Explosion: If this model is reduced to 0 wounds, roll 2D6 before removing it from the battlefield. If you roll a 6 on either dice, it explodes, and each unit within 2D6" suffers D6 mortal wounds; if you roll a 6 on both dice, each unit within 3D6" suffers D6 mortal wounds instead.

Super-heavy Walker: This model can Fall Back in the Movement phase and still shoot and/or charge in the same turn. When this model, it can move over enemy **INFANTRY** and **SWARM** models, though it must end its move more than 1" from any enemy units. In addition, this model can move and fire Heavy weapons without suffering the penalty to its hit rolls. Finally, this model only gains a bonus to its save for being in cover if at least half of the model is obscured from the firer.

FACTION KEYWORDS

IMPERIUM, IMPERIAL KNIGHTS, <QUESTOR ALLEGIANCE>, <HOUSEHOLD>

KEYWORDS

TITANIC, VEHICLE, DOMINUS CLASS, KNIGHT VALIANT

Cette fiche technique vous permet de jouer votre nouvelle unité. Pour les règles complètes, référez-vous au Codex ou à l'Index correspondant à votre armée.

KNIGHT VALIANT

30
POISSANCE

DÉGÂTS

Certaines caractéristiques changent si des dégâts sont subis, comme indiqué ci-dessous :

PV RESTANTS	M	CC	CT
15-28+	10"	4+	3+
8-14	7"	5+	4+
1-7	4"	6+	5+

NOM	M	CC	CT	F	E	PV	A	Gd	Sv
Knight Valiant	*	*	*	8	8	28	4	9	3+

Un Knight Valiant est une figurine individuelle équipée d'un harpon Thundercoil, d'un canon Conflagration, d'un canon Siegebreaker jumelé, de deux fuseurs jumelés, de quatre missiles Shieldbreaker et de pieds titanesques.

ARMES	PORTÉE	TYPE	F	PA	D	APTITUDES
Canon Conflagration	18"	Lourde 3D6	7	-2	2	Cette arme touche automatiquement sa cible.
Missile Shieldbreaker	48"	Lourde 1	10	-4	D6	Chaque missile Shieldbreaker ne peut tirer qu'une fois par bataille, et une figurine ne peut en tirer qu'un par tour. Les jets de sauvegarde invulnérables ne peuvent pas être effectués contre les blessures infligées par cette arme.
Canon Siegebreaker jumelé	48"	Lourde 2D3	7	-1	D3	-
Harpon Thundercoil	12"	Lourde 1	16	-6	10	Vous pouvez relancer les jets de touche ratés lorsque cette arme cible les unités VÉHICULE ou MONSTRE . De plus, si cette arme inflige des dégâts, l'unité cible subit D3 blessures mortelles supplémentaires.
Fuseur jumelé	12"	Assaut 2	8	-4	D6	Si la cible est à mi-portée ou moins de cette arme, jetez deux dés lorsque vous infligez ses dégâts et défaissez le résultat plus bas.
Pieds titanesques	Mêlée	Melée	Util.	-2	D3	Faites 3 jets de touche pour chaque attaque avec cette arme.

OPTIONS D'ÉQUIPEMENT

- Peut remplacer deux de ses missiles Shieldbreaker par un canon Siegebreaker jumelé.

APTITUDES

Bouclier Ionique: Cette figurine a une sauvegarde invulnérable de 5+ contre les armes de tir.

Explosion de Biréacteur à Plasma: Si cette figurine est réduite à 0 PV, jetez 2D6 avant de la retirer du champ de bataille. Si un des dés donne 6, elle explose, et chaque unité à 2D6" ou moins subit D6 blessures mortelles; si les deux dés donnent 6, chaque unité à 3D6" ou moins subit D6 blessures mortelles à la place.

Marcheur Super-lourd: Cette figurine peut Battre en Retraite en phase de Mouvement et quand même tirer et/ou charger au même tour. Lorsque cette figurine Bat en Retraite, elle peut se déplacer par-dessus les figurines d'**INFANTERIE** et **NUÉE** ennemies, mais doit terminer son mouvement à plus de 1" de toute unité ennemie. De plus, Cette figurine peut se déplacer et tirer avec des armes Lourdes sans pénalité à ses jets de touche. Enfin, cette figurine ne gagne un bonus à sa sauvegarde dû au couvert que si elle est au moins à moitié masquée à la vue du tireur.

MOTS-CLÉS DE FACTION

IMPERIUM, IMPERIAL KNIGHTS, <ALLÉGEANCE QUESTOR>, <MAISONNÉE>

MOTS-CLÉS

TITANESQUE, VÉHICULE, CLASSE DOMINUS, KNIGHT VALIANT

Estas reglas esenciales te permitirán desplegar tu nueva unidad en el campo de batalla. Para conseguir las reglas completas de esta unidad, consulta el Codex o Index relativo a tu ejército.

KNIGHT VALIANT



30
POTENCIA

NOMBRE	M	HA	HP	F	R	H	A	L	S
Knight Valiant	*	*	*	8	8	28	4	9	3+

Un Knight Valiant es una miniatura única equipada con un arpón espiral de trueno, cañón de conflagración, cañón rompeesquidos doble, dos rifles de plasma dobles, cuatro misiles rompeesquidos y pie titánico.

ARMA	ALC.	TIPO	F	FP	D	HABILIDADES
Cañón de conflagración	18"	Pesada 3D6	7	-2	2	Esta arma impacta automáticamente a su blanco.
Misil rompeesquidos	48"	Pesada 1	10	-4	1D6	Cada misil rompeesquidos sólo puede dispararse una vez por batalla, y cada miniatura sólo puede disparar un misil rompeesquidos cada turno. No pueden realizarse salvaciones invulnerables contra las heridas causadas por esta arma.
Cañón rompeesquidos doble	48"	Pesada 2D3	7	-1	1D3	-
Arpón espiral de trueno	12"	Pesada 1	16	-6	10	Puedes repetir las tiradas para impactar fallidas con esta arma que tomen como blanco a unidades VEHICULO o MONSTRUO . Adicionalmente, si esta arma inflige daño, la unidad elegida como blanco sufre 1D3 heridas mortales adicionales.
Rifle de fusión doble	12"	Asalto 2	8	-4	1D6	Si el blanco está a la mitad del alcance máximo del arma, o más cerca, tira 2D6 y descarta el más bajo para infligir daño con ella.
Pie titánico	Com.	Com.	Port.	-2	1D3	Haz 3 tiradas para impactar por cada ataque realizado con esta arma, en lugar de 1.

DAÑO

Ciertos atributos de esta miniatura cambian cuando sufre daño, como indica esta tabla:

H RESTANTES	M	HA	HP
15-28+	10"	4+	3+
8-14	7"	5+	4+
1-7	4"	6+	5+

OPCIONES DE EQUIPO

- Esta miniatura puede reemplazar dos de sus misiles rompeesquidos por un cañón rompeesquidos doble.

HABILIDADES

Andador superpesado. Esta miniatura puede Retirarse en la fase de movimiento y a pesar de ello disparar y/o cargar en el mismo turno. Cuando esta miniatura se Retira, puede mover sobre miniaturas de **INFANTERÍA** y **ENJAMBRE** enemigas, aunque debe terminar su movimiento a más de 1" de cualquier unidad enemiga. Adicionalmente, esta miniatura puede mover y disparar armas pesadas sin sufrir el penalizador a sus tiradas para impactar. Por último, esta miniatura sólo recibe un bonificador a su salvación por estar en cobertura si al menos la mitad de la miniatura queda a cubierto de quien dispara sobre ella.

Escudo iónico. Esta miniatura tiene una salvación invulnerable de 5+ contra ataques a distancia.

Explosión del doble núcleo de plasma. Si esta miniatura queda reducida a 0 heridas, tira 2D6 antes de retirarla del campo de batalla; si obtienes un 6 en cualquiera de los dos dados explota y cada unidad a 2D6" o menos sufre 1D6 heridas mortales. Si obtienes un 6 en ambos dados, cada unidad a 3D6" o menos sufre 1D6 heridas mortales.

CLAVES DE FACCIÓN

IMPERIUM, IMPERIAL KNIGHTS, <LEALTAD DE QUESTOR>, <CASA>

CLAVES

TITÁNICO, VEHÍCULO, CLASE DOMINUS, KNIGHT VALIANT

Mit diesen Regeln kannst du deine neue Einheit gleich in die Schlacht führen – die vollständigen Regeln findest du im Codex oder Index für deine Armee.

KNIGHT VALIANT



30

MACHT

SCHADEN

Manche Werte dieses Modells ändern sich, wenn es in der Schlacht Schaden erleidet:

ÜBRIGE LP	B	KG	BF
15-28+	10"	4+	3+
8-14	7"	5+	4+
1-7	4"	6+	5+

NAME	B	KG	BF	S	W	LP	A	MW	RW
Knight Valiant	*	*	*	8	8	28	4	9	3+

Ein Knight Valiant ist ein einzelnes Modell. Es ist mit einer Donnerspulenharpune, einer Feuersbrunstanone, einer Zwillingsbelagerungsbrecherkanone, zwei Zwillingsmeltern, vier Schildbrecherraketen und Titanischen Füßen bewaffnet.

WAFFE	REICHW.	TYP	S	DS	SW	FÄHIGKEITEN
-------	---------	-----	---	----	----	-------------

Donnerspulenharpune	12"	Schwer 1	16	-6	10	Du kannst für diese Waffe misslungene Verwundungswürfe gegen FAHRZEUG - und gegen MONSTER -Einheiten wiederholen. Wenn diese Waffe Schaden verursacht, erleidet das Ziel zusätzliche W3 tödliche Verwundungen.
Feuersbrunstanone	18"	Schwer 3W6	7	-2	2	Diese Waffe trifft ihr Ziel automatisch.
Schildbrecherrakete	48"	Schwer 1	10	-4	W6	Jede Schildbrecherrakete kann nur einmal pro Schlacht abgefeuert werden und ein Modell kann nicht mehr als eine Schildbrecherrakete pro Zug abfeuern. Gegen Verwundungen durch diese Waffe können keine Rettungswürfe abgelegt werden.
Zwillingsbelagerungsbrecherkanone	48"	Schwer 2W3	7	-1	W3	-
Zwillingsmelter	12"	Sturm 2	8	-4	W6	Wenn sich das Ziel innerhalb der halben Reichweite dieser Waffe befindet, wirf bei der Ermittlung ihres Schadens zwei Würfel und lege das niedrigere Ergebnis ab.
Titanische Füße	Nahkampf	Nahkampf	Träger	-2	W3	Führe 3 Trefferwürfe für jede Attacke mit dieser Waffe aus.

AUSRÜSTUNGSOPTIONEN

- Dieses Modell darf zwei seiner Schildbrecherraketen durch eine einzelne Zwillingsbelagerungsbrecherkanone ersetzen.

FÄHIGKEITEN

Ionenschild: Dieses Modell hat einen Rettungswurf von 5+ gegen Fernkampfaffen.

Doppelplasmakernexplosion: Wenn dieses Modell auf 0 Lebenspunkte reduziert wird, wirfst du 2W6, bevor du es vom Schlachtfeld entfernst. Zeigt einer der beiden Würfel eine 6, explodiert das Modell und jede Einheit innerhalb von 2W6 Zoll erleidet W6 tödliche Verwundungen; wenn beide Würfel eine 6 zeigen, erleidet stattdessen jede Einheit innerhalb von 3W6 Zoll W6 tödliche Verwundungen.

Superschwerer Läufer: Dieses Modell kann sich in der Bewegungsphase zurückziehen und dennoch im selben Zug schießen und/oder angreifen. Wenn sich dieses Modell zurückzieht, kann es sich über feindliche **INFANTERIE**- und **SCHWARM**-Modelle bewegen, muss seine Bewegung jedoch weiter als 1 Zoll von feindlichen Einheiten entfernt beenden. Zusätzlich kann sich dieses Modell bewegen und Schwere Waffen abfeuern, ohne den Abzug auf Trefferwürfe zu erleiden. Dieses Modell erhält nur dann einen Bonus für Deckung auf seinen Schutzwurf, wenn mindestens die Hälfte des Modells für den Schießenden nicht sichtbar ist.

FRAKTION

IMPERIUM, IMPERIAL KNIGHTS, <QUESTOR-TREUE>, <HAUS>

SCHLÜSSELWÖRTER

TITANISCH, FAHRZEUG, DOMINUS-KLASSE, KNIGHT VALIANT

Queste regole base ti aiuteranno a portare sul campo di battaglia la tua nuova unità; per le regole complete consulta il Codex o l'Index corrispondente alla tua armata.

KNIGHT VALIANT

30
 POTENZA

DANNI

Alcune caratteristiche di questo modello cambiano come segue man mano che subisce danni:

FE RIMANENTI	M	AC	AB
15-28+	10"	4+	3+
8-14	7"	5+	4+
1-7	4"	6+	5+

NOME	M	AC	AB	Fo	R	Fe	A	D	S
Knight Valiant	*	*	*	8	8	28	4	9	3+

Un Knight Valiant è un singolo modello armato di arpione thundercoil, cannone conflagrazione, doppio cannone spezzassedi, due doppi fucili termici, quattro missili spaccascudi e piedi titanici.

ARMA	GITTATA	TIPO	Fo	VP	Da	ABILITÀ
Cannone conflagrazione	18"	Pesante 3D6	7	-2	2	Quest'arma colpisce automaticamente il bersaglio.
Missile spaccascudi	48"	Pesante 1	10	-4	D6	Ciascun missile spaccascudi può essere utilizzato solo una volta per battaglia, e in ogni turno un modello può spararne solo uno. Contro le ferite causate da quest'arma non possono essere effettuati tiri invulnerabilità.
Doppio cannone spezzassedi	48"	Pesante 2D3	7	-1	D3	-
Arpione thundercoil	12"	Pesante 1	16	-6	10	Puoi ripetere i tiri per colpire falliti quando scegli un'unità VEICOLO o MOSTRO come bersaglio per quest'arma. Inoltre, se quest'arma infligge qualsiasi danno, l'unità bersaglio subisce D3 ferite mortali addizionali.
Doppio fucile termico	12"	Assalto 2	8	-4	D6	Se il bersaglio si trova entro metà gittata di quest'arma, tira due dadi quando infliggi danni con essa e scarta il risultato più basso.
Piedi titanici	Mischia	Mischia	Mod.	-2	D3	Effettua 3 tiri per colpire per ogni attacco sferrato con quest'arma.

OPZIONI DI EQUIPAGGIAMENTO • Sostituire due missili spaccascudi con un doppio cannone spezzassedi.

ABILITÀ

Scudo Ionico: questo modello ha un tiro invulnerabilità di 5+ contro le armi da tiro.

Esplosione a Catena del Nucleo Plasma: se questo modello viene ridotto a 0 ferite tira 2D6 prima di rimuoverlo dal campo di battaglia. Se il risultato di uno dei due dadi è 6, esso esplode, e ogni unità entro 2D6" subisce D6 ferite mortali; se invece il risultato di entrambi i dadi è 6, ogni unità entro 3D6" subisce D6 ferite mortali.

Camminatore Superpesante: questo modello può Ripiegare nella fase di Movimento e comunque sparare e/o caricare nello stesso turno. Quando questo modello Ripiega, può muoversi sopra i modelli di **FANTERIA** e **SCIAME** nemici, ma deve terminare il proprio movimento a più di 1" da qualsiasi unità nemica. Inoltre, questo modello può muoversi e sparare con armi Pesanti senza subire la penalità ai tiri per colpire. Infine, questo modello ottiene il bonus ai tiri salvezza conferiti dalla copertura solo se almeno metà del modello è oscurata a colui che spara.

KEYWORDS DI FAZIONE

IMPERIUM, IMPERIAL KNIGHTS, <ALLEANZA DEL QUESTOR>, <CASATA>

KEYWORDS

TITANICO, VEICOLO, CLASSE DOMINUS, KNIGHT VALIANT

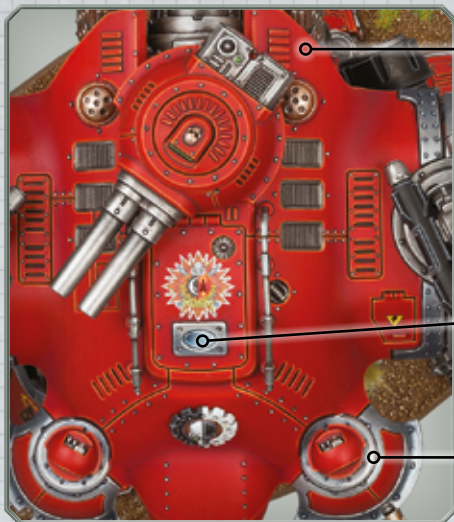

BASE MEPHISTON RED
SHADE CARROBURG CRIMSON
LAYER EVIL SUNZ SCARLET
LAYER TROLL SLAYER ORANGE

BASE WARLOCK BRONZE
SHADE NULN OIL
LAYER BRASS SCORPION
LAYER STORMHOST SILVER

BASE THE FANG
SHADE NULN OIL
LAYER RUSS GREY
LAYER FENRISIAN GREY

BASE LEADBELCHER
SHADE AGRAX EARTHSHADE
LAYER IRONBREAKER
LAYER STORMHOST SILVER

BASE RAKARTH FLESH
SHADE REIKLAND FLESHSHADE
LAYER PALLID WYCH FLESH
LAYER WHITE SCAR

BASE AVERLAND SUNSET
SHADE CASANDORA YELLOW
LAYER YRIEL YELLOW
EDGE DORN YELLOW

BASE ABADDON BLACK
LAYER DARK REAPER
LAYER DAWNSTONE
LAYER ADMINISTRATUM GREY

BASE CALEDOR SKY
LAYER TEMPLE GUARD BLUE
EDGE BAHARROTH BLUE
LAYER WHITE SCAR

