

WARHAMMER
40,000

JUNITH ERUITA

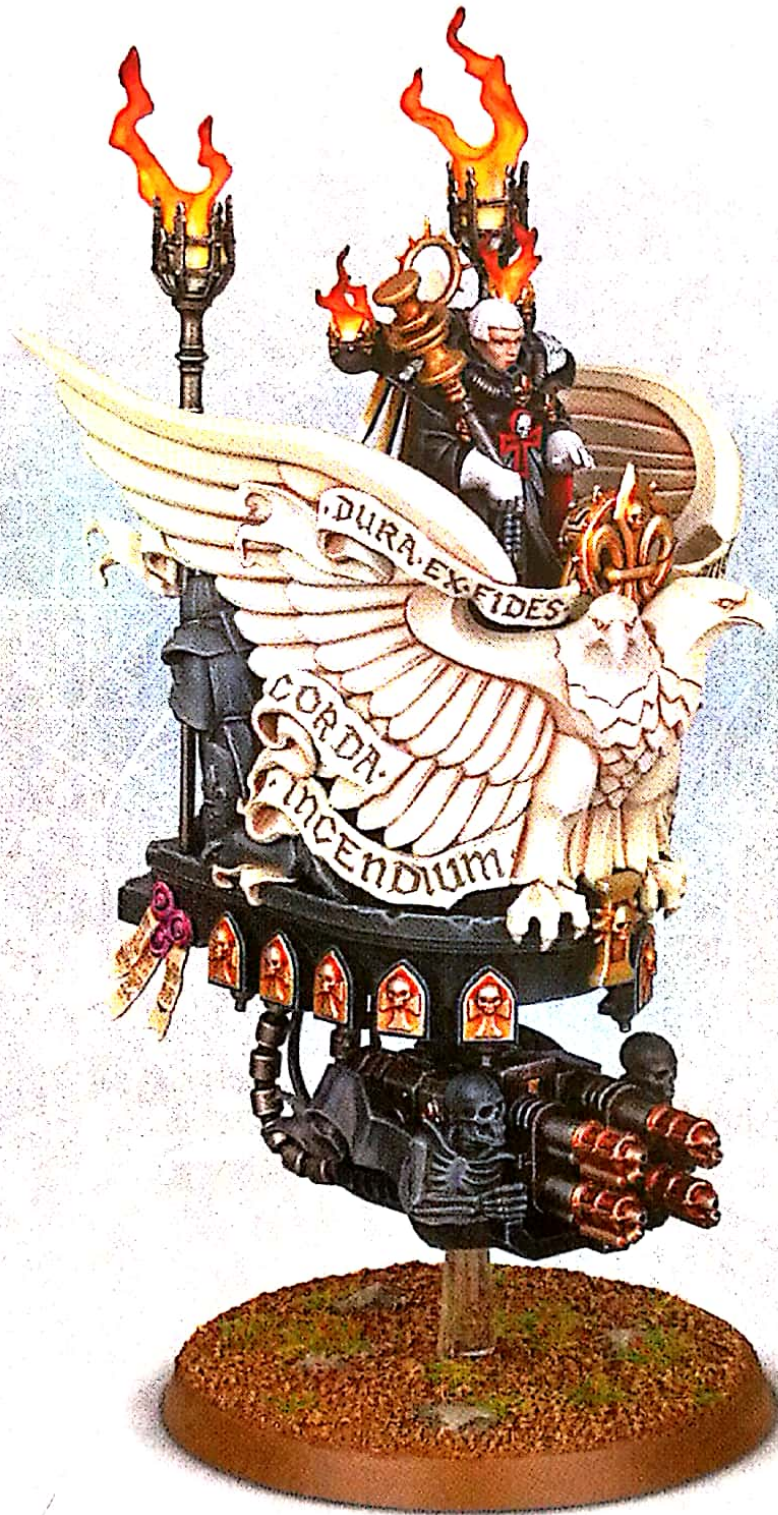



• **READ THIS FIRST** • **À LIRE EN PREMIER** • **LEER ANTES DE MONTAR**
 • **LIES DIES ZUERST** • **LEGGI PRIMA QUESTO**

- **BEFORE ASSEMBLING YOUR MINIATURES, PLEASE READ THROUGH THE INSTRUCTIONS IN THIS BOOKLET CAREFULLY.** A pair of plastic cutters is required to remove the plastic components in this kit from their frame. We advise using a mouldline scraping tool to clean up the parts. To assemble your model you will need plastic glue. Games Workshop sells Citadel Fine Detail Cutters, Citadel Mouldline Remover and Citadel Plastic Glue, but does not recommend these products for use by children under the age of 16 without adult supervision.
- **AVANT D'ASSEMBLER VOS FIGURINES, VEUILLEZ LIRE ATTENTIVEMENT LES INSTRUCTIONS DE CE LIVRET.** Une pince coupante est requise pour détacher chaque élément de sa grappe. Nous vous recommandons l'utilisation d'un grattoir pour ébarber les éléments. Pour l'assemblage, vous aurez également besoin de colle plastique. Games Workshop commercialise les Pinces de Précision Citadel, l'Ébarboir Citadel et la Colle Plastique Citadel, mais n'en recommande pas l'utilisation pour des enfants de moins de 16 ans sans la supervision d'un adulte.
- **POR FAVOR, LEE CUIDADOSAMENTE ESTE LIBRETO DE INSTRUCCIONES ANTES DE EMPEZAR A MONTAR LAS MINIATURAS.** Te harán falta unas tenazas para plástico a fin de separar las piezas de la matriz. También aconsejamos una herramienta para rebabas a fin de limpiar cada pieza. Para montar la miniatura necesitarás pegamento para plástico. Games Workshop vende Tenazas Citadel, Herramientas para rebabas Citadel y Pegamento para plástico Citadel, pero no recomienda estos productos a menores de 16 años sin la supervisión de un adulto.
- **VOR DEM ZUSAMMENBAU DER MINIATUREN BITTE DIE ANWEISUNGEN IN DIESER ANLEITUNG AUFMERKSAM DURCHLESEN.** Du benötigst einen Kunststoffseitenschneider, um die Kunststoffbauteile aus dem Gussrahmen herauszutrennen, und Kunststoffkleber, um die Miniatur zusammenzubauen. Außerdem empfehlen wir, die Bauteile vorher mit einem Gussgratentferner zu säubern. Games Workshop bietet Präzisions-Kunststoffseitenschneider von Citadel sowie Citadel-Kunststoffkleber an, empfiehlt aber, dass Kinder unter 16 Jahren diese nur unter Aufsicht eines Erwachsenen benutzen.
- **PRIMA DI ASSEMBLARE LE TUE MINIATURE LEGGI ATTENTAMENTE TUTTE LE ISTRUZIONI DI QUESTO LIBRETTO.** Sono necessarie un paio di tronchesine per plastica per staccare i componenti dai loro sprue. Consigliamo di usare un attrezzo apposito per pulire i componenti. Per assemblare il modello avrai bisogno di colla per plastica. Games Workshop vende Tronchesine di precisione Citadel, Attrezzo per ripulire Citadel e Colla per plastica Citadel, ma non consiglia questi prodotti ad un pubblico minore di 16 anni senza la supervisione di un adulto.

• **EXPLANATION OF SYMBOLS** • **EXPLICATION DES SYMBOLES** • **EXPLICACIÓN DE SÍMBOLOS**
 • **ERLÄUTERUNG DER SYMBOLE** • **LEGENDA DEI SIMBOLI**



- Choice of parts
- Choix d'éléments
- Modelos de componentes
- Auswahl an Teilen
- Scelta di componenti



- Special instruction - Please read
- Instructions spéciales - Lire attentivement
- Instrucción especial: Por favor, léela
- Besondere Anweisung - Bitte lesen
- Istruzioni speciali - Leggi attentamente



- Stage complete
- Étape terminée
- Paso completado
- Schritt abgeschlossen
- Fase completa



- Dry fit stage before gluing
- Tester avant de coller
- Comprobar el encaje antes de pegar
- Positionierung erst ohne Klebstoff ausprobieren
- Prova a secco prima di incollare

1 a

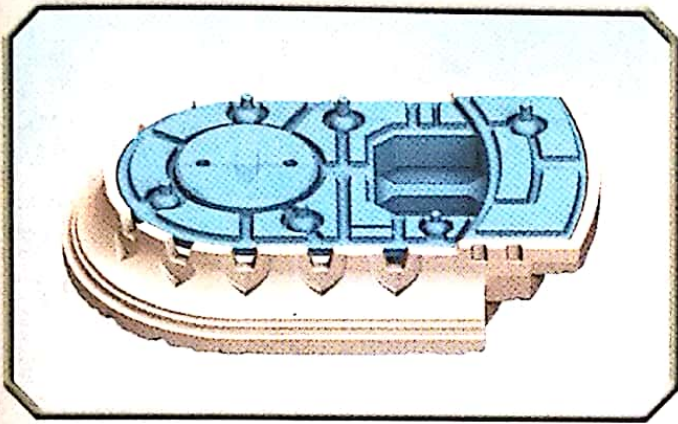
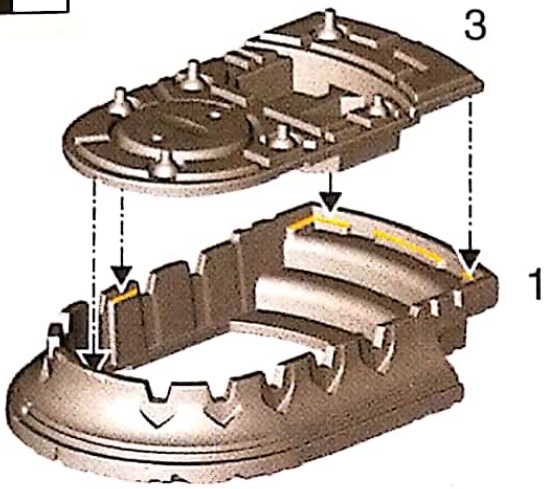

1 b

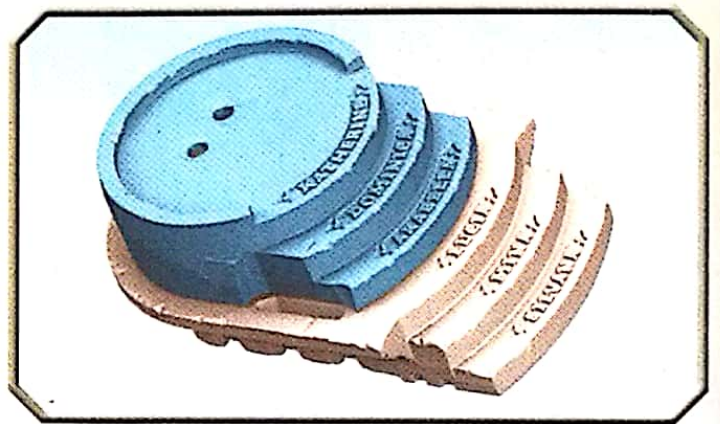
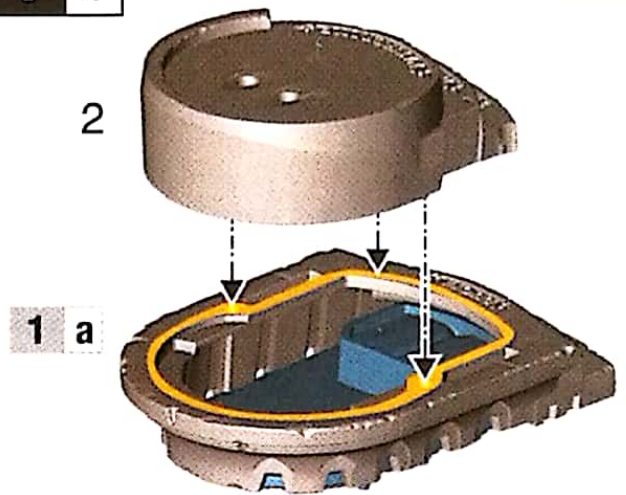

1 c

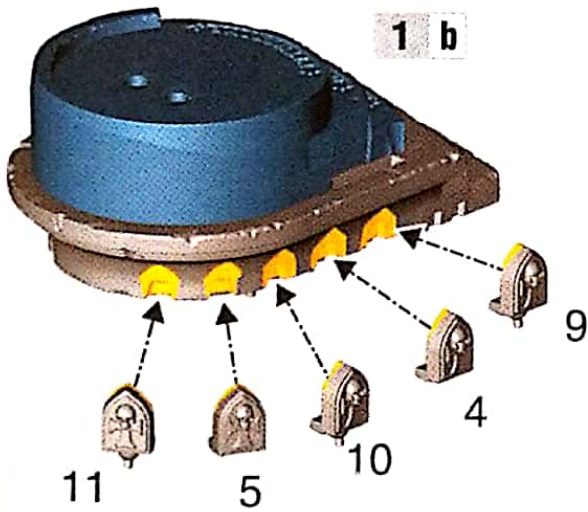

1 d

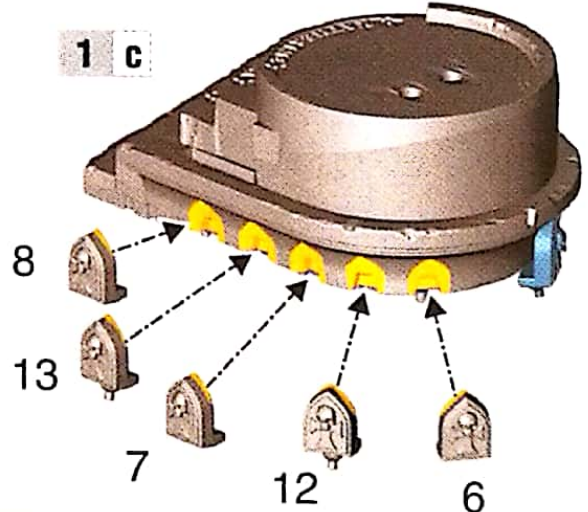

2

17

19

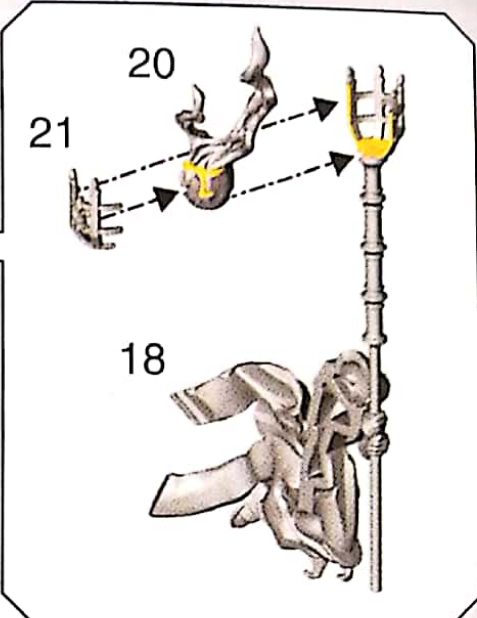
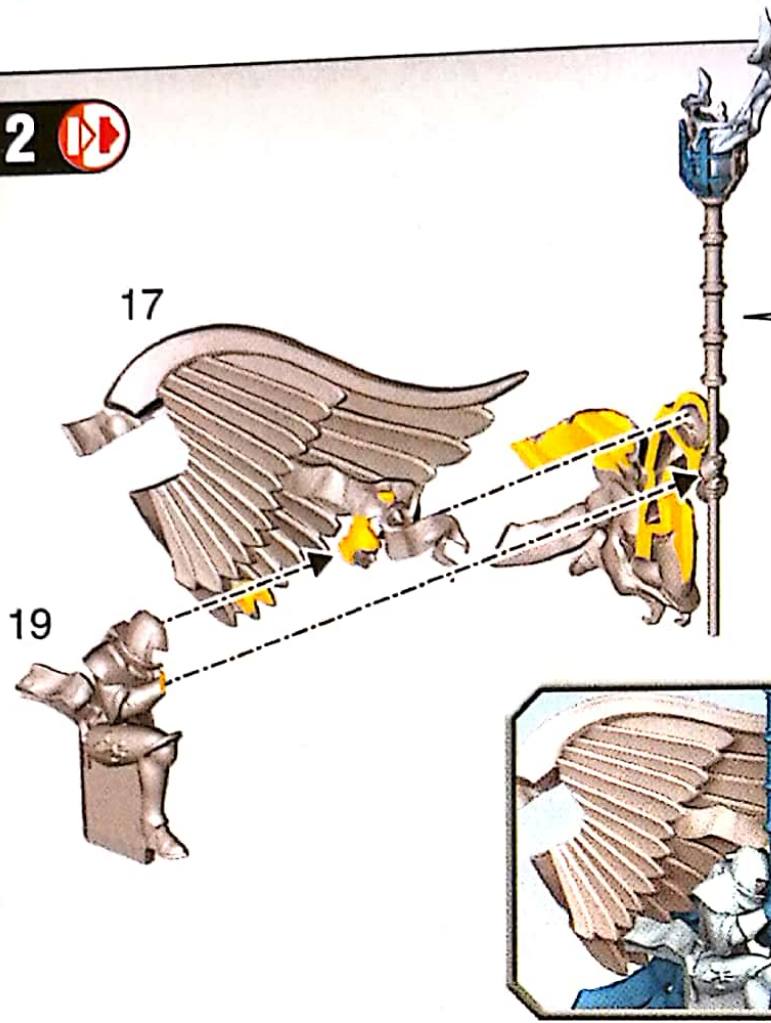

3

22

24

25 26

23

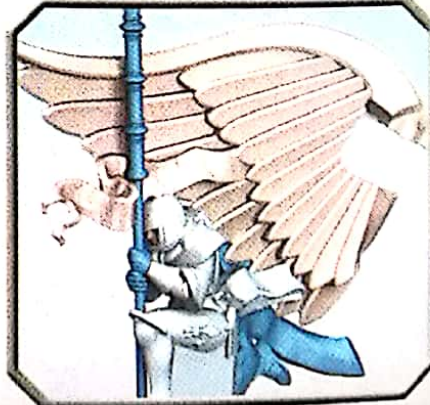
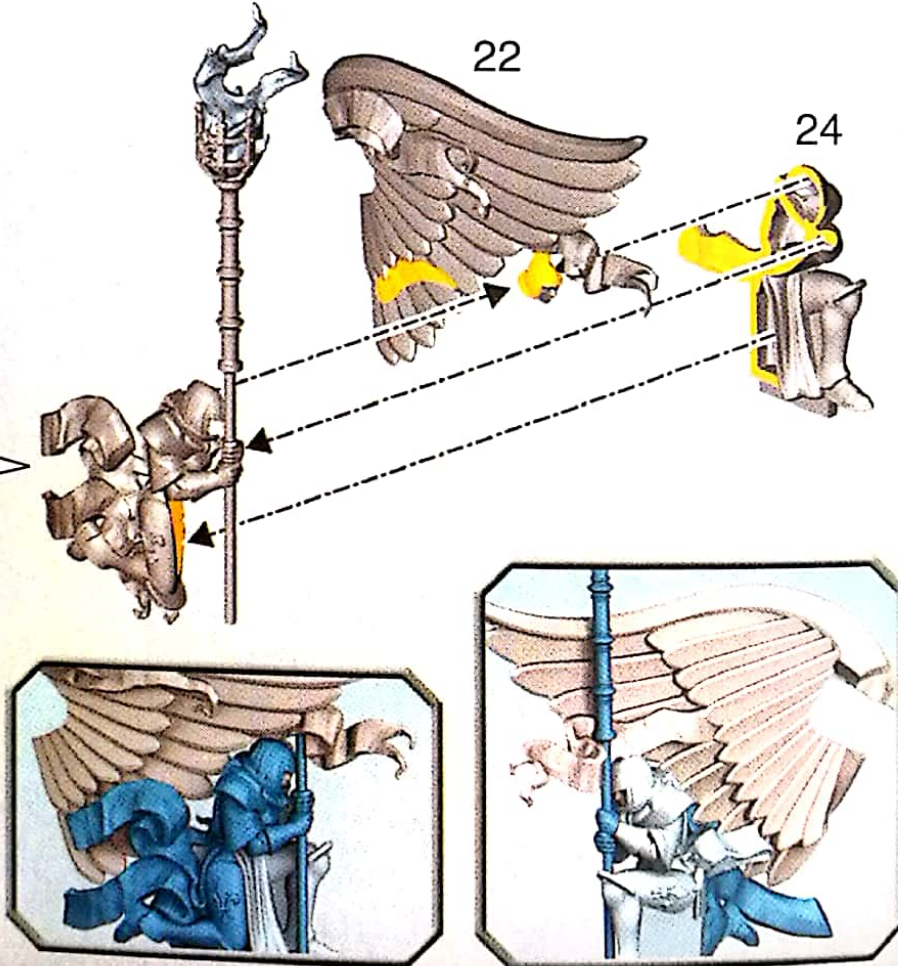
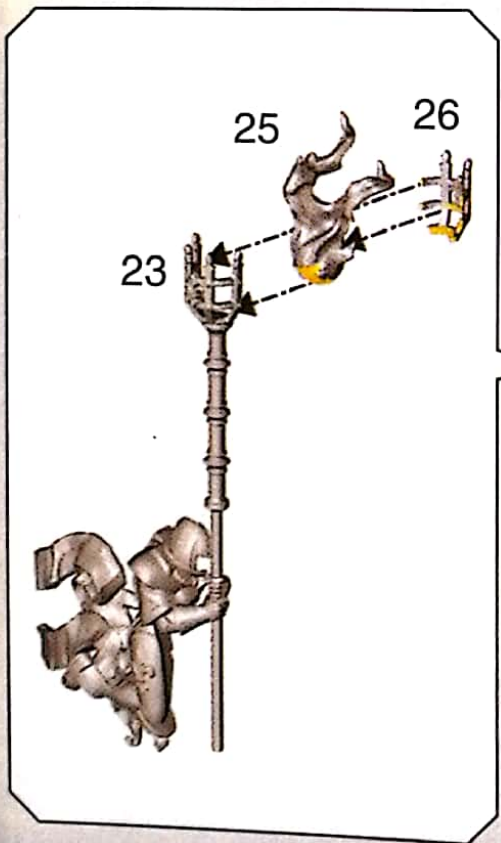

4 a

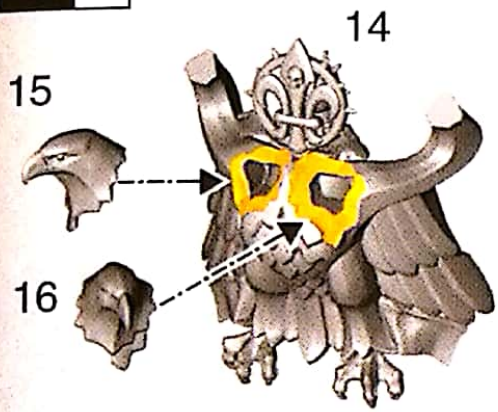

4 b

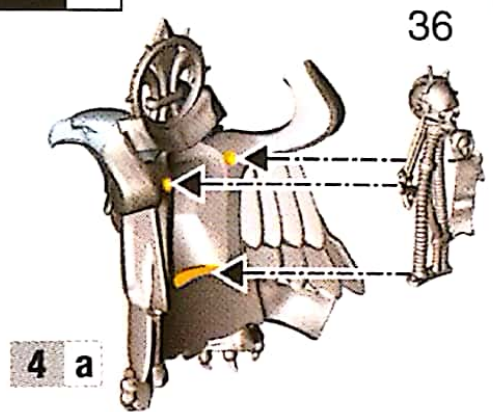

5 

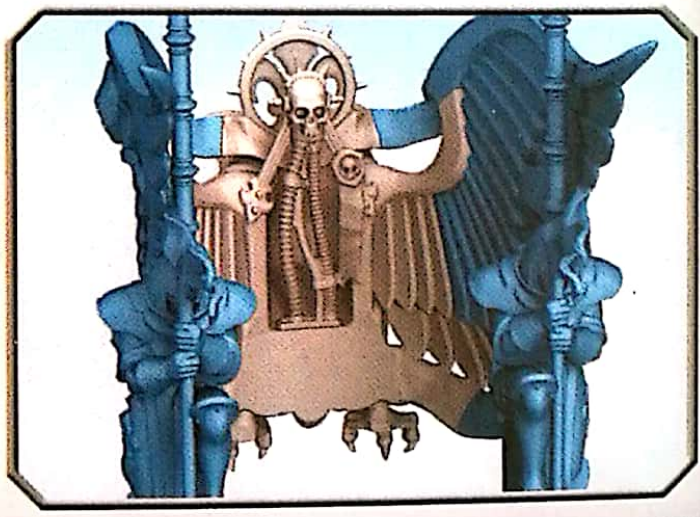
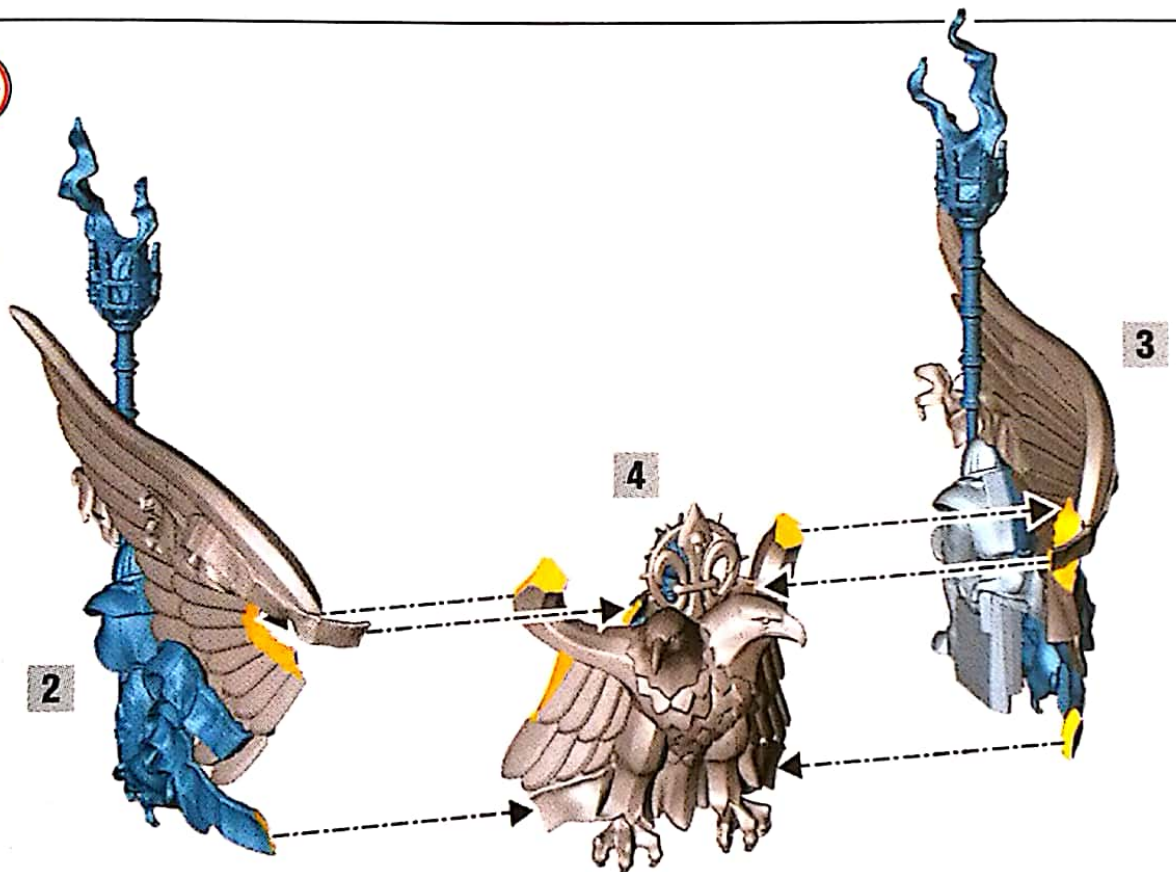

6 a

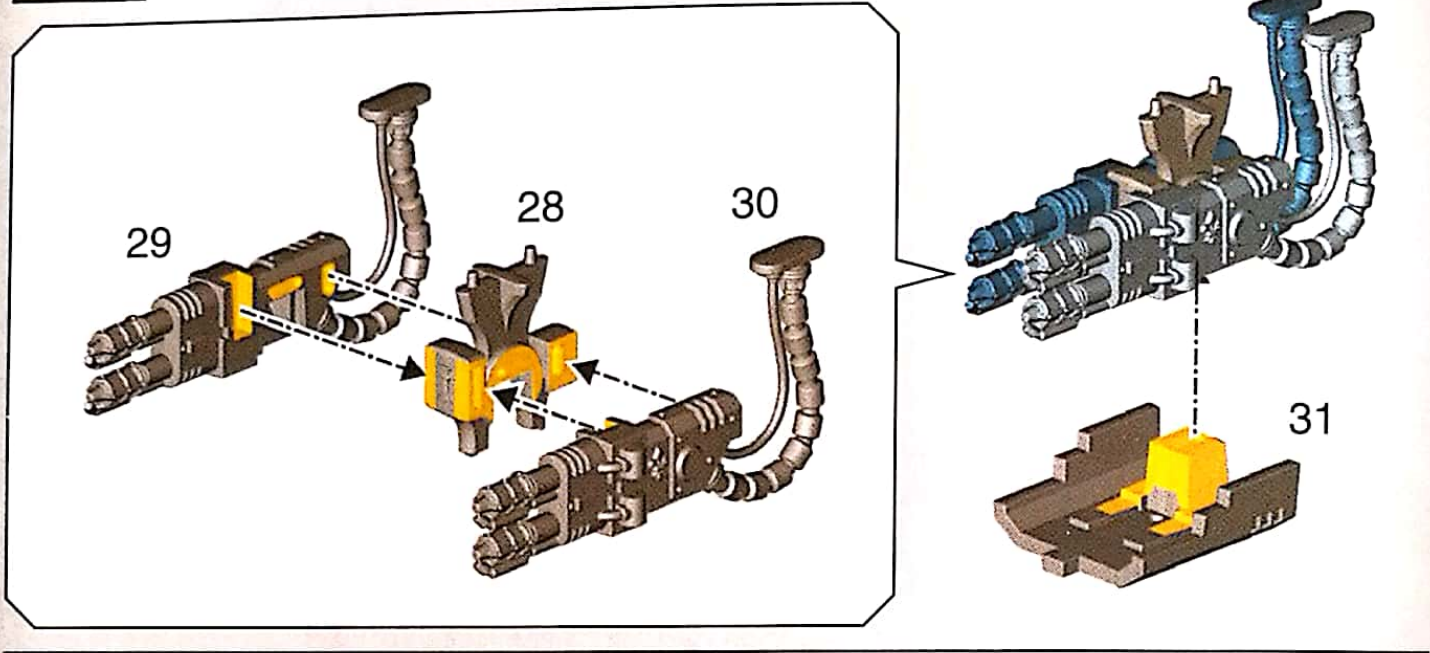

6 b

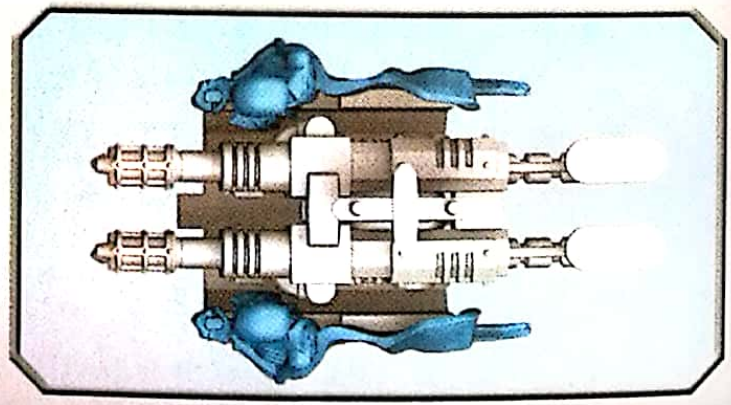
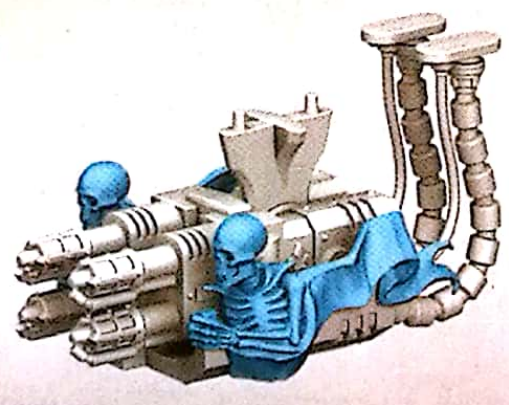
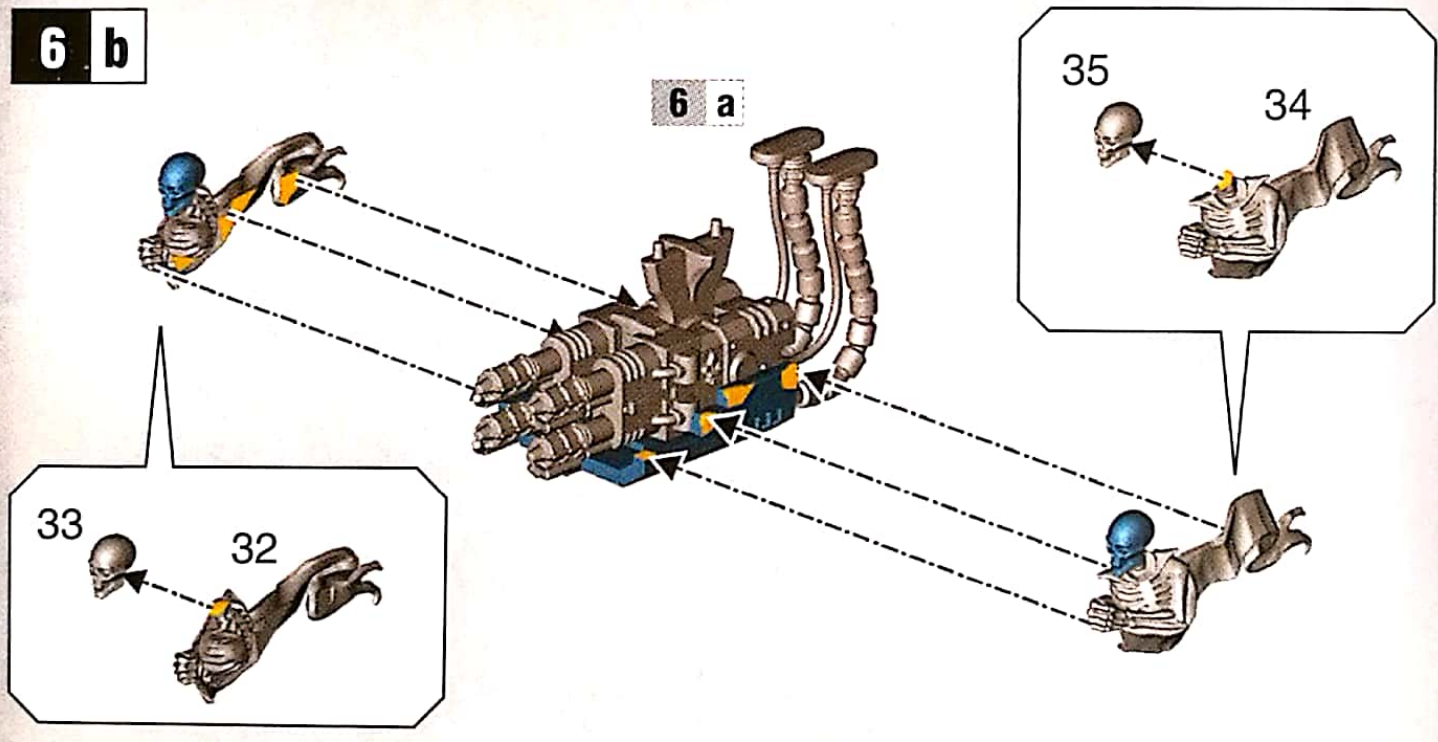

7 a

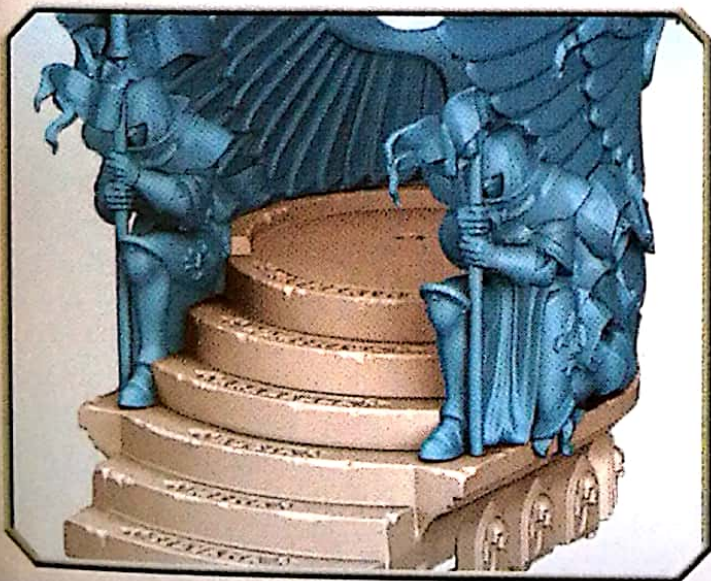
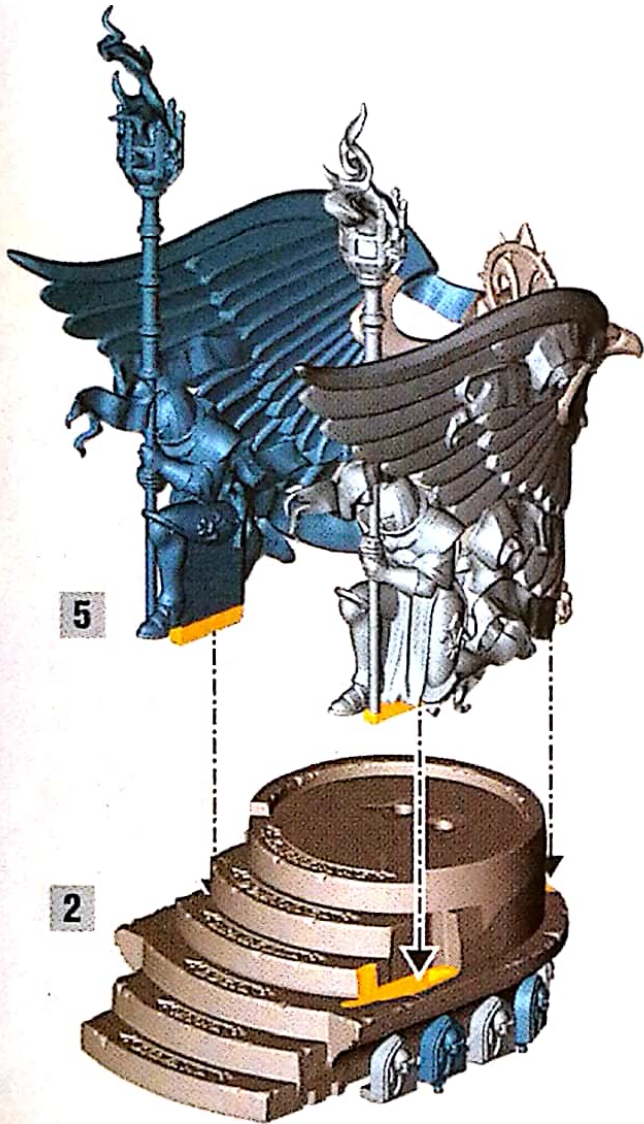

7 b

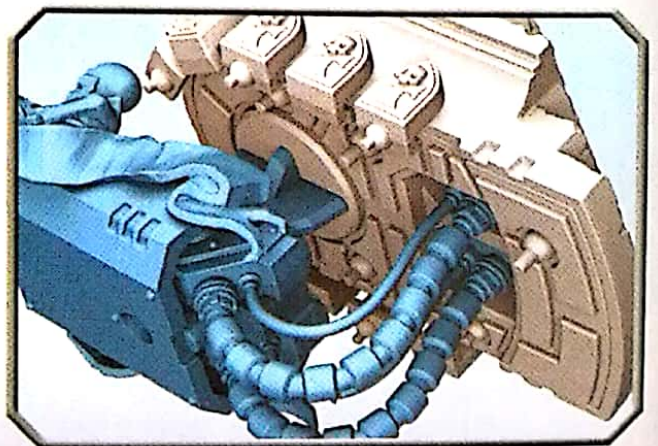
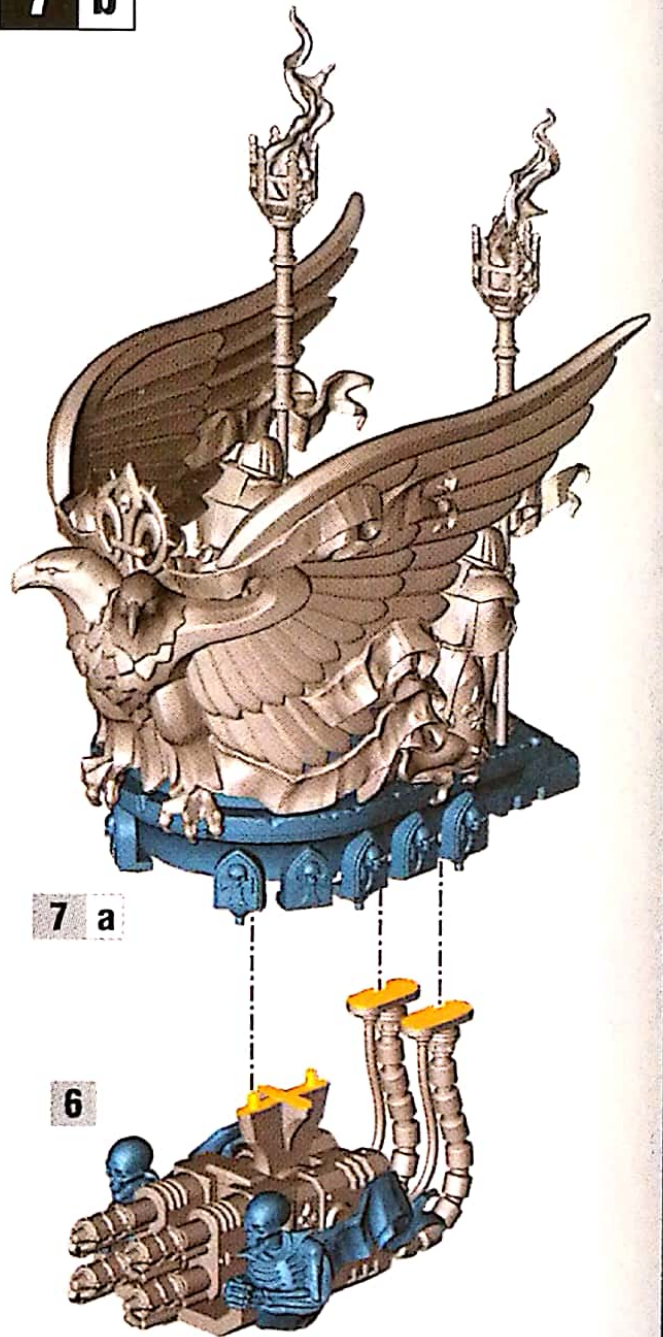

8 a

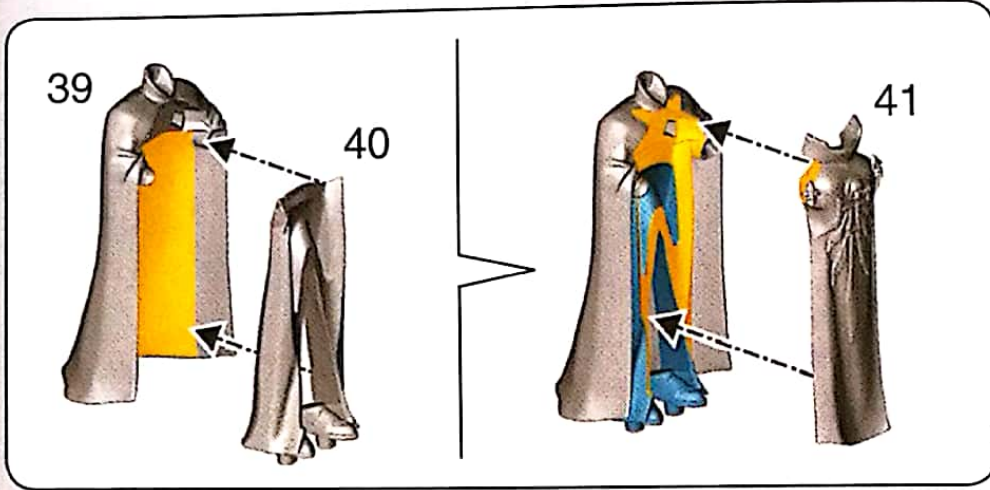

42



8 b

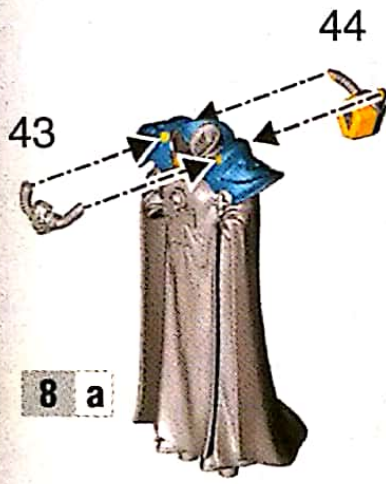

8 c

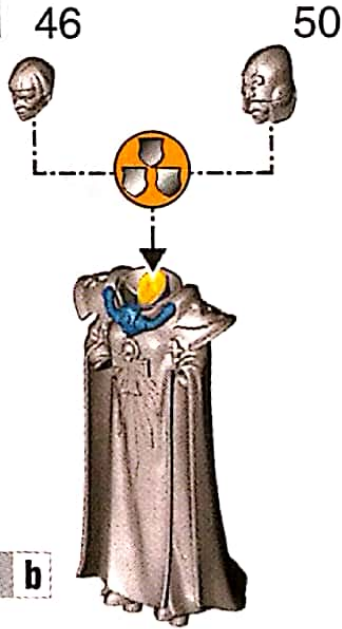

8 d

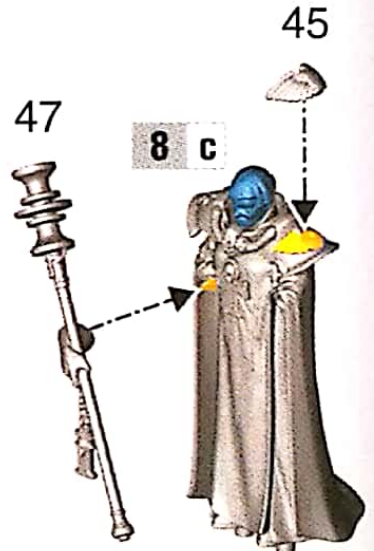

8 e

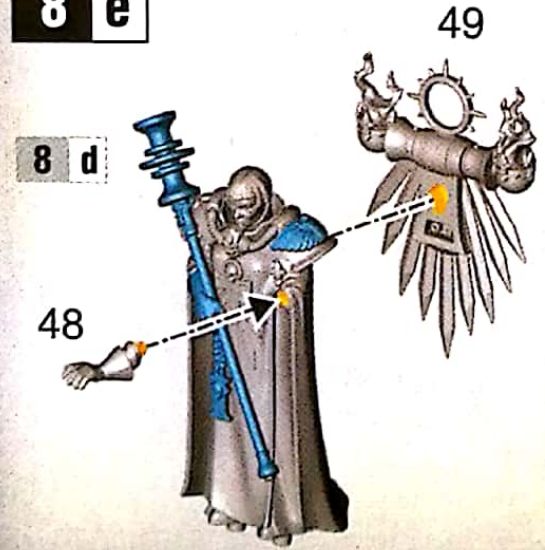

9 a

8



7 b

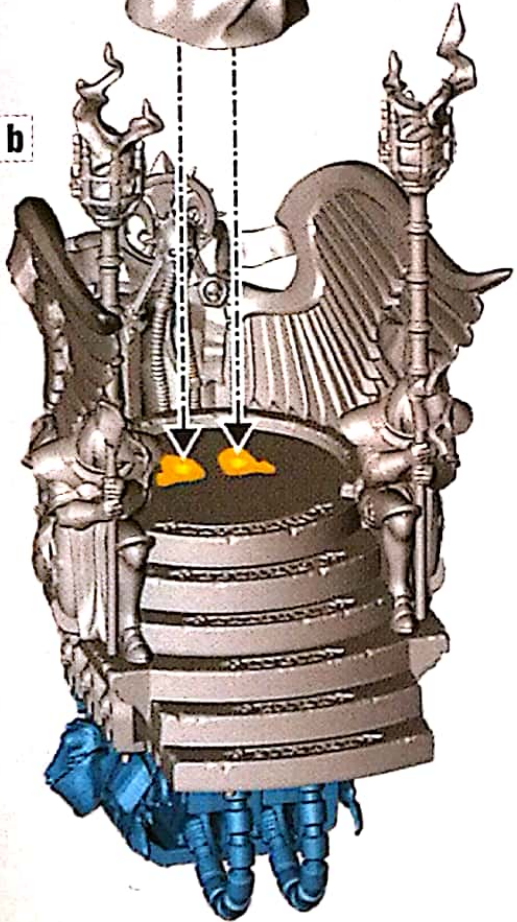

9 b

9 a

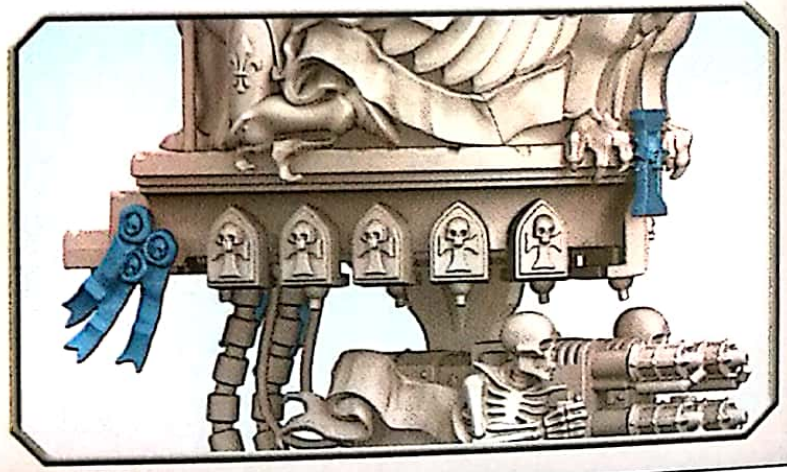
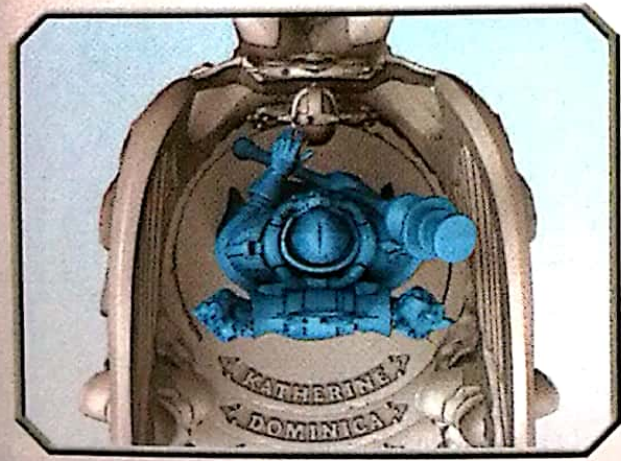
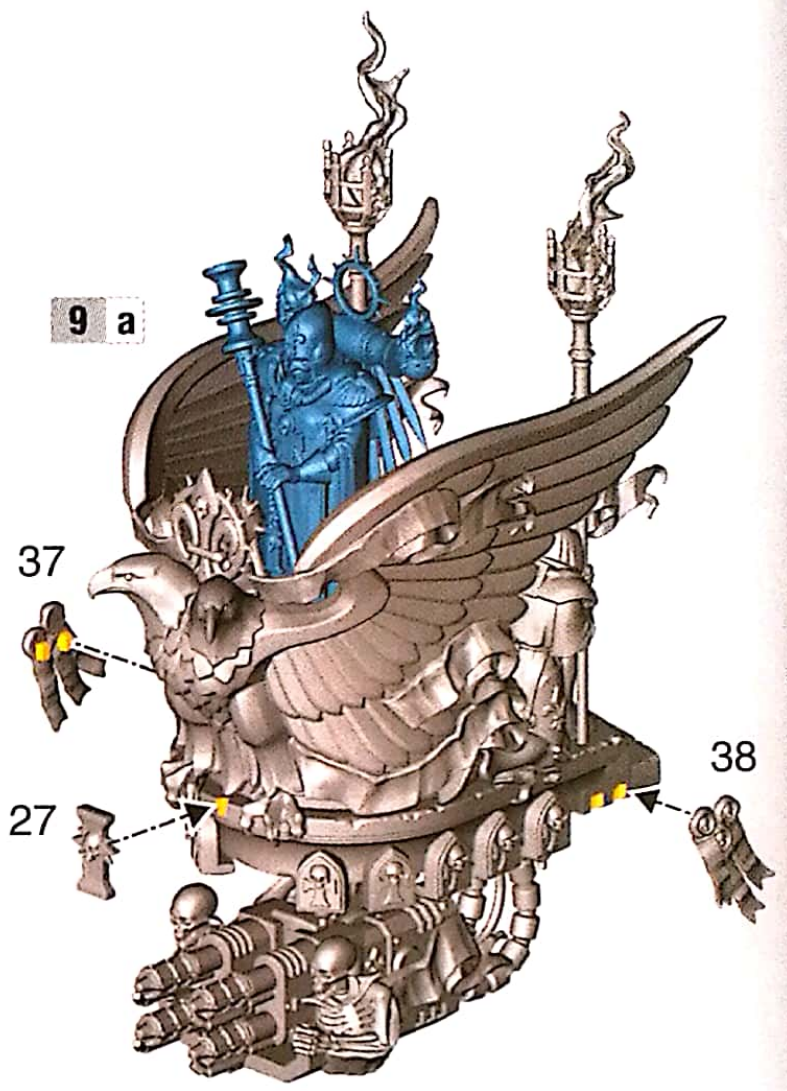

9 c

9 b

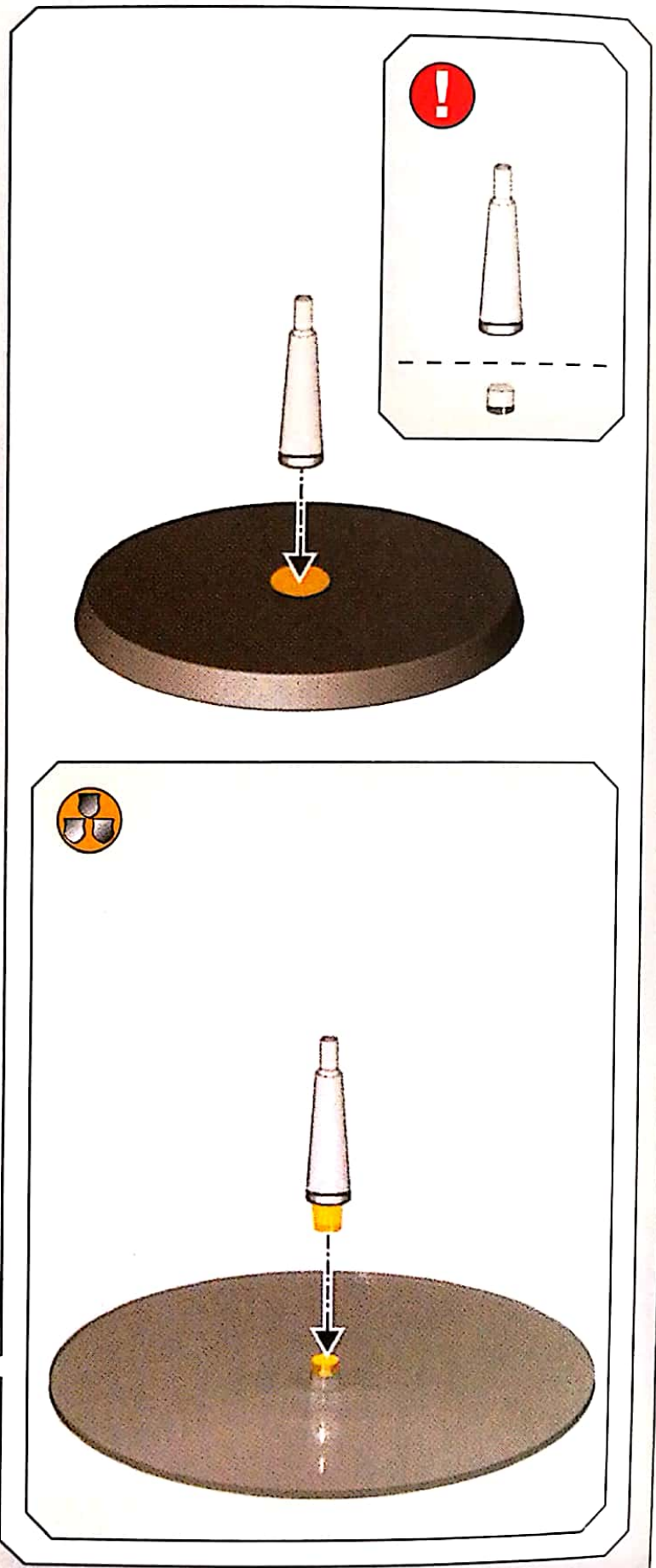
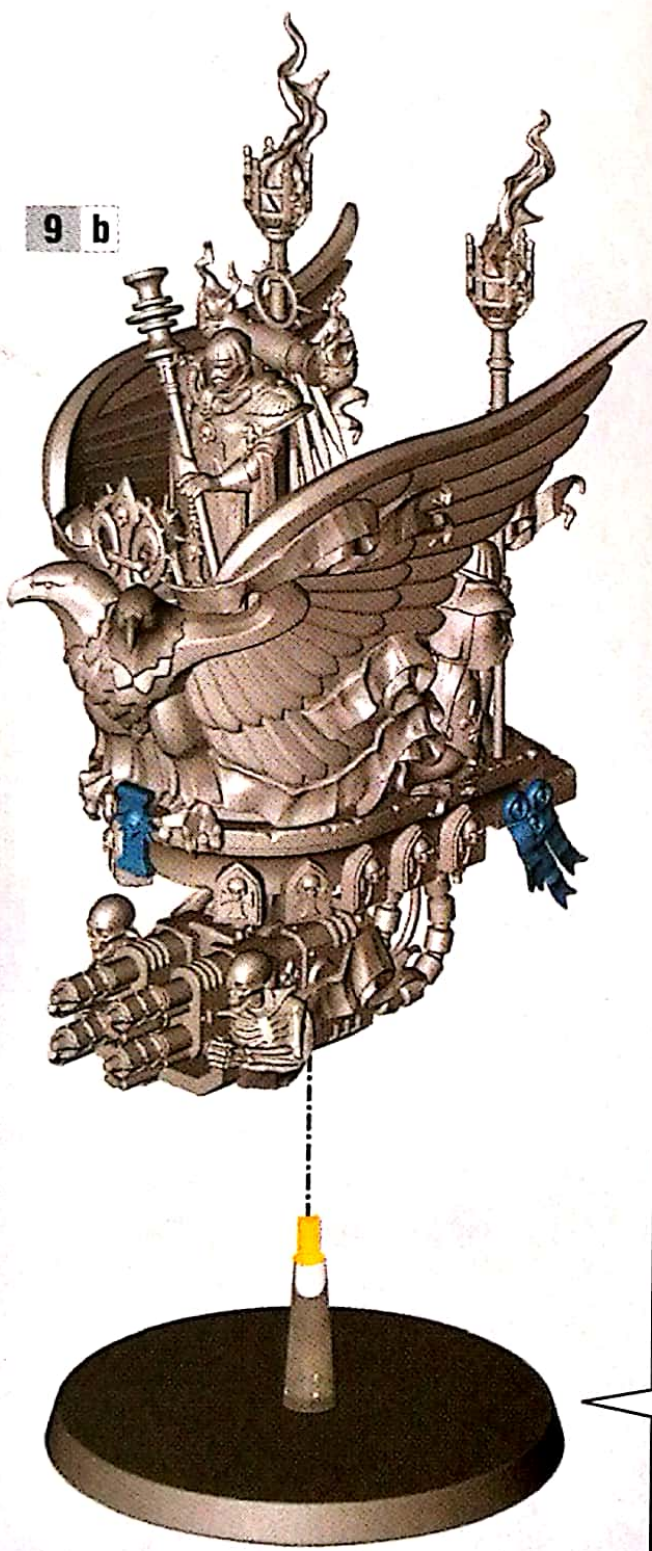

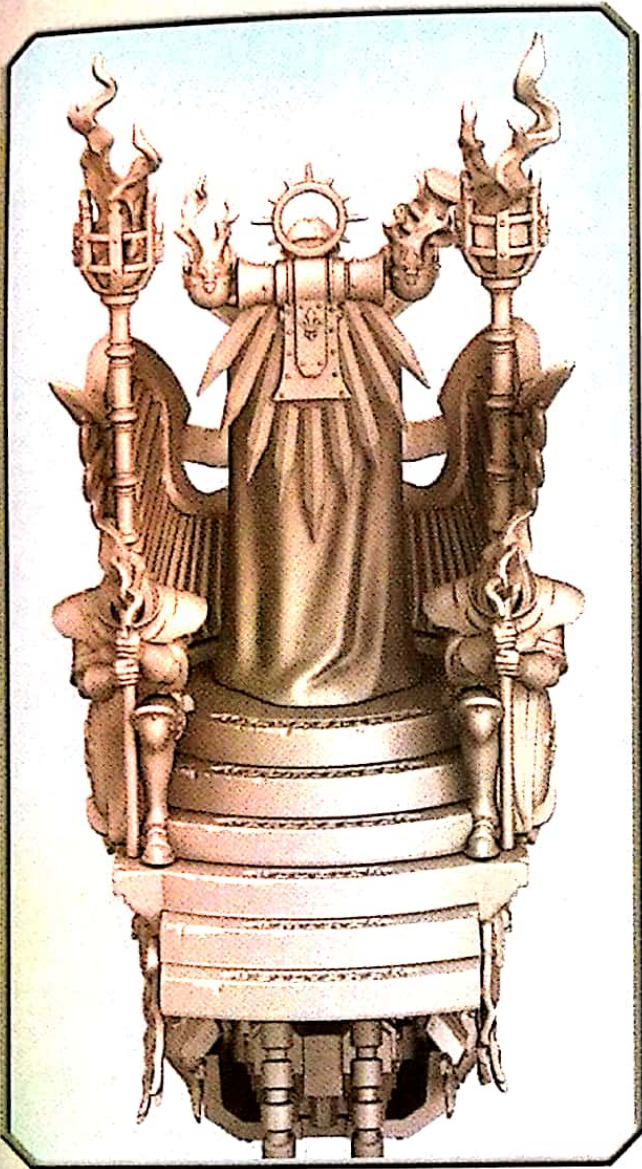

CITADEL
PAINT SYSTEM



BASE BALTHASAR GOLD

SHADE REIKLAND FLESHSHADE

LAYER GEHENNA'S GOLD

LAYER STORMHOST SILVER

BASE ABADDON BLACK

LAYER DARK REAPER

LAYER THUNDERHAWK BLUE

LAYER ULTHUAN GREY



JUNITH ERUITA

NAME	M	WS	BS	S	T	W	A	Ld	Sv
Junith Eruita	10"	2+	2+	3	4	7	4	9	3+

Junith Eruita is a single model equipped with: 2 heavy flammers; the Mace of Castigation. You can only include one of this model in your army.

WEAPONS	RANGE	TYPE	S	AP	D	ABILITIES
Heavy flamer	8"	Heavy D6	5	-1	1	When resolving an attack made with this weapon, do not make a hit roll: it automatically scores a hit.
The Mace of Castigation	Melee	Melee	+2	-1	2	-

ABILITIES

Acts of Faith, Sacred Rites, Shield of Faith

Rosarius: This model has a 4+ invulnerable save.

Fiery Conviction: Re-roll hit rolls of 1 and wound rolls of 1 for attacks made by models in friendly **ORDER OF OUR MARTYRED LADY** units whilst their unit is within 6" of this model.

The Pulpit of Saint Holline's Basilica: The invulnerable save friendly **ADEPTA SORORITAS INFANTRY** models receive from the Shield of Faith ability is improved by 1, to a maximum of 4+, whilst their unit is within 6" of this model.

Explodes: When this model is destroyed, roll one D6 before removing it from play. On a 6 it explodes, and each unit within 3" suffers 1 mortal wound.

FACTION KEYWORDS

IMPERIUM, ADEPTUS MINISTORUM, ADEPTA SORORITAS, ORDER OF OUR MARTYRED LADY

KEYWORDS

CHARACTER, VEHICLE, FLY, CANONESS SUPERIOR, JUNITH ERUITA



JUNITH ERUITA

NOM	M	CC	GT	F	E	PV	A	Cd	Sv
Junith Eruita	10"	2+	2+	3	4	7	4	9	3+

Junith Eruita est une figurine individuelle équipée de: 2 lance-flammes lourds; la Masse de Castigation. Vous ne pouvez inclure cette figurine à votre armée qu'en un seul exemplaire.

ARMES	PORTÉE	TYPE	F	PA	D	APTITUDES
Lance-flammes lourd	8"	Lourde D6	5	-1	1	Quand vous résolvez une attaque de cette arme, ne faites pas de jet de touche: elle touche automatiquement.
La Masse de Castigation	Mêlée	Mêlée	+2	-1	2	-

APTITUDES

Actes de Foi, Rites Sacrés, Bouclier de la Foi

Rosarius: Cette figurine a une sauvegarde invulnérable de 4+.

Conviction Brûlante: Relance les jets de touche de 1 et les jets de blessure de 1 pour les attaques des figurines de l'**ORDRE DE NOTRE-DAME DES MARTYRS** amies tant que leur unité est à 6" ou moins de cette figurine.

Chaire de la Basilique Sainte Holline: La sauvegarde invulnérable conférée par l'aptitude Bouclier de la Foi aux figurines d'**INFANTRIE** de l'**ADEPTA SORORITAS** amies est améliorée de 1, jusqu'à un maximum de 4+, tant que leur unité est à 6" ou moins de cette figurine.

Explosion: Quand cette figurine est détruite, jetez un D6 avant de la retirer du jeu. Sur 6 elle explose, et chaque unité à 3" ou moins subit 1 blessure mortelle.

MOTS-CLÉS DE FACTION

IMPERIUM, ADEPTUS MINISTORUM, ADEPTA SORORITAS, ORDRE DE NOTRE-DAME DES MARTYRS

MOTS-CLÉS

PERSONNAGE, VÉHICULE, VOL, CANONESS SUPERIOR, JUNITH ERUITA



JUNITH ERUITA

NOMBRE	M	HA	HP	F	R	H	A	L	S
Junith Eruita	10"	2+	2+	3	4	7	4	9	3+

Junith Eruita es una sola miniatura equipada con: 2 lanzallamas pesados y La Mitra de Castigo. Sólo puedes incluir una miniatura como esta en tu ejército.

ARMA	ALCANCE	TIPO	F	FP	D	HABILIDADES
Lanzallamas pesado	8"	Pesada 1D6	5	-1	1	Al resolver un ataque con esta arma, no hagas tirada para impactar; logra impactar automáticamente.
La Maza de Castigo	Combate	Combate	+2	-1	2	-

HABILIDADES

Actos de fe, Ritos Sagrados, Escudo de la fe

Convicción feroz. Repite las tiradas de 1 para impactar y para herir de ataques realizados por miniaturas en unidades **ORDEN DE NUESTRA SEÑORA MÁRTIR** amigas a 6" o menos de esta miniatura.

Rosarius. Esta miniatura tiene una salvación invulnerable de 4+.

El púlpito de la Basílica de San Holline. La salvación invulnerable que reciben las miniaturas de **INFANTERÍA ADEPTA SORORITAS** amigas por la habilidad Escudo de la fe mejora en 1, hasta un máximo de 4+, mientras esas unidades se encuentren a 6" o menos de esta miniatura.

Explosión. Cuando esta miniatura es destruida, tira 1D6 antes de retirarla de juego. Con un 6 explota y cada unidad a 3" o menos de ella sufre 1 herida mortal.

CLAVES DE FACCIÓN

IMPERIUM, ADEPTUS MINISTORUM, ADEPTA SORORITAS, ORDEN DE NUESTRA SEÑORA MÁRTIR

CLAVES

PERSONAJE, VEHÍCULO, VOLAR, CANONESS SUPERIOR, JUNITH ERUITA



JUNITH ERUITA

NAME	B	KG	BF	S	W	LP	A	MW	RW
Junith Eruita	10"	2+	2+	3	4	7	4	9	3+

Junith Eruita ist ein einzelnes Modell und ausgerüstet mit: 2 Schweren Flammenwerfern; dem Streitkolben der Züchtigung. Dieses Modell darf nur einmal in deiner Armee enthalten sein.

WAFFE	REICHW.	TYP	S	DS	SW	FÄHIGKEITEN
Schwerer Flammenwerfer	8"	Schwer W6	5	-1	1	Wenn du eine Attacke mit dieser Waffe abhandelst, führe keinen Trefferwurf durch: sie trifft automatisch.
Streitkolben der Züchtigung	Nahkampf	Nahkampf	+2	-1	2	-

FÄHIGKEITEN

Glaubensakte, Heilige Riten, Schild des Glaubens

Rosarius: Dieses Modell hat einen Rettungswurf von 4+.

Feuriger Schußspruch: Wiederhole Trefferwürfe von 1 und Verwundungswürfe von 1 für Attacken von Modellen in befreundeten Einheiten des **ORDENS DER HEILIGEN MÄRTYRERIN**, solange sich ihre Einheit innerhalb von 6 Zoll um dieses Modell befindet.

Die Kanzel der Basilika der Heiligen Holline: Verbessere den Rettungswurf befreundeter **INFANTERIE**-Modelle der **ADEPTA SORORITAS**, den sie durch die Fähigkeit *Schild des Glaubens* erhalten, um 1, solange sich ihre Einheit innerhalb von 6 Zoll um dieses Modell befindet, bis zu einem Maximum von 4+.

Explosion: Wenn dieses Modell zerstört wird, wirf einen W6, bevor du es aus dem Spiel entfernst. Bei einer 6 explodiert es und jede Einheit innerhalb von 3 Zoll erleidet 1 tödliche Verwundung.

FRAKTION

IMPERIUM, ADEPTUS MINISTORUM, ADEPTA SORORITAS, ORDEN DER HEILIGEN MÄRTYRERIN

SCHLÜSSELWÖRTER

CHARAKTERMODELL, FAHRZEUG, FLIEGEN, CANONESS SUPERIOR, JUNITH ERUITA

ITALIANO

Queste regole essenziali ti aiuteranno a portare sul campo di battaglia la tua nuova unità; per le regole complete consulta il Codex corrispondente alla tua armata.



JUNITH ERUITA

NOME	M	AG	AB	Fd	R	FE	A	D	S
Junith Eruita	10"	2+	2+	3	4	7	4	9	3+

Junith Eruita è un singolo modello equipaggiato con: 2 lanciafiamme pesanti; Mazza del Castigo. Puoi includere solo un modello di questo tipo nella tua armata.

ARMA	GITTATA	TIPO	Fd	VP	DA	ABILITÀ
Lanciafiamme pesante	8"	Pesante D6	5	-1	1	Quando risolvi un attacco effettuato con quest'arma non effettuare un tiro per colpire: essa mette automaticamente a segno un colpo.
Mazza del Castigo	Mischia	Mischia	+2	-1	2	-

ABILITÀ

Atti di Fede, Riti Sacri, Scudo di Fede

Rosarius: questo modello ha un tiro invulnerabilità di 4+.

Accesa Convinzione: ripeti i tiri per colpire pari a 1 e i tiri per ferire pari a 1 degli attacchi effettuati dai modelli delle unità dell'**ORDINE DI NOSTRA SIGNORA MARTIRE** amiche fintanto che la loro unità si trova entro 6" da questo modello.

Pulpito della Basilica di Sant'Holline: il tiro invulnerabilità che i modelli delle unità di **FANTERIA** dell'**ADEPTA SORORITAS** ricevono dall'abilità Scudo di Fede migliora di 1, fino a un massimo di 4+, fintanto che la loro unità si trova entro 6" da questo modello.

Esplose: quando questo modello viene distrutto tira un D6 prima di rimuoverlo dal gioco. Con 6 esplose e ogni unità entro 3" subisce 1 ferita mortale.

KEYWORDS DI FAZIONE

IMPERIUM, ADEPTUS MINISTORUM, ADEPTA SORORITAS, ORDINE DI NOSTRA SIGNORA MARTIRE

KEYWORDS

PERSONAGGIO, VEICOLO, VOLARE, CANONESS SUPERIOR, JUNITH ERUITA

games-workshop.com



993201080585



MADE IN THE UK

Games Workshop Limited. NG7 2WS, UK
© Copyright Games Workshop Limited 2020.

