

**1 a**

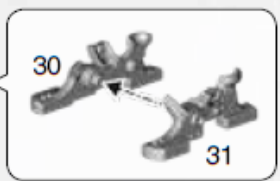

**1 b**

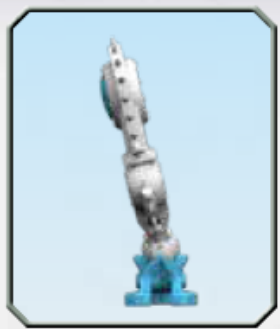
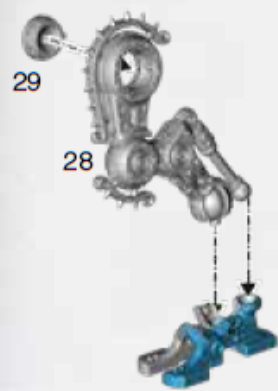
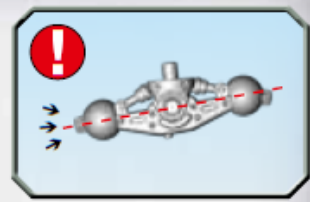
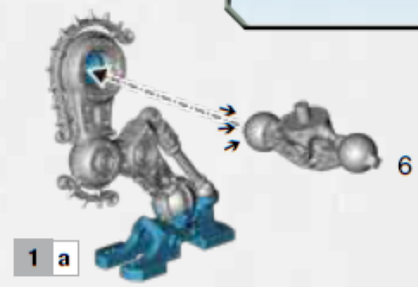

**1 c**

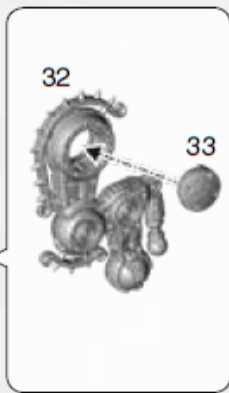
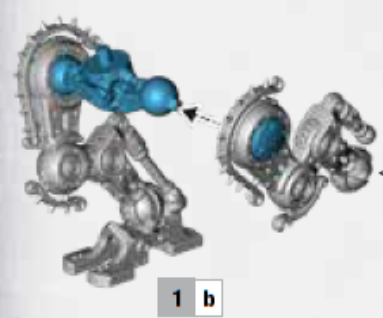

**1 d**

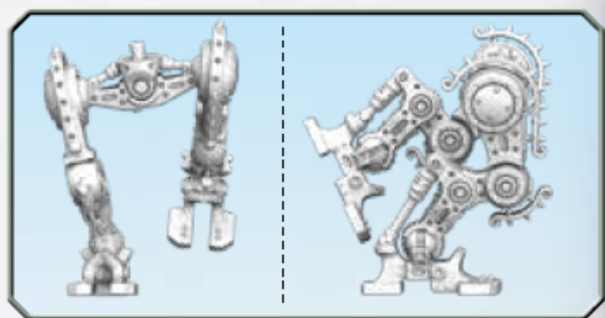
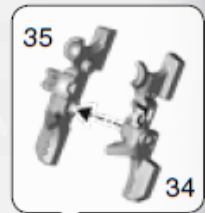
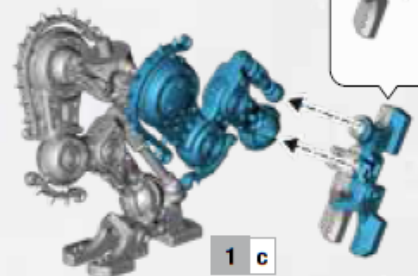

**2 a**

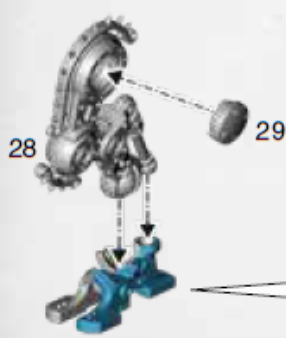

**2 b**

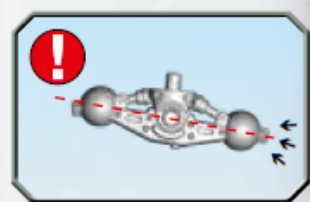
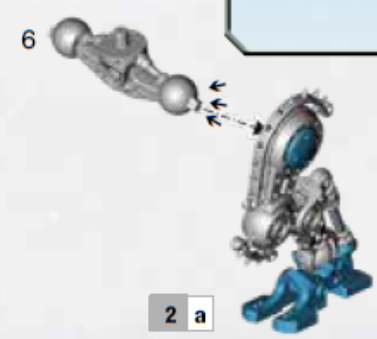

**2 a**

**2 c**

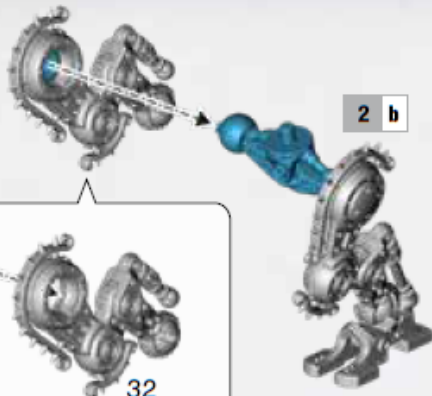

**2 b**

**2 d**

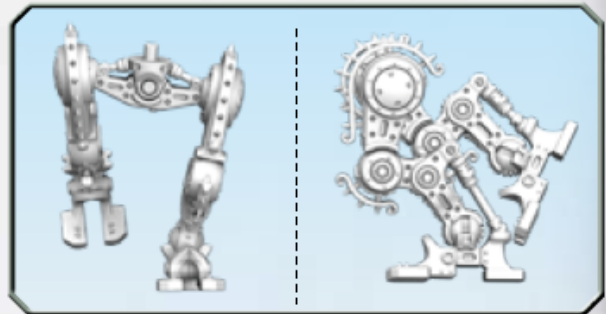
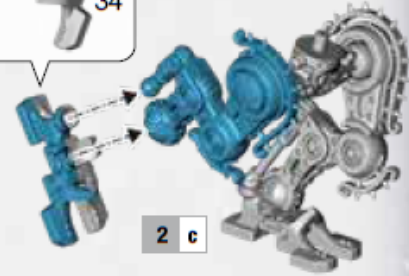
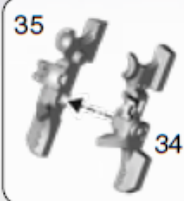

**3 a x2**

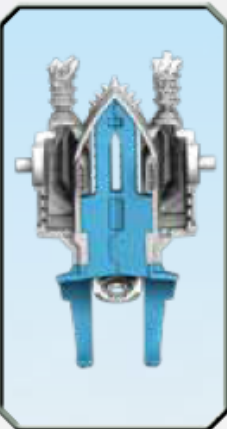
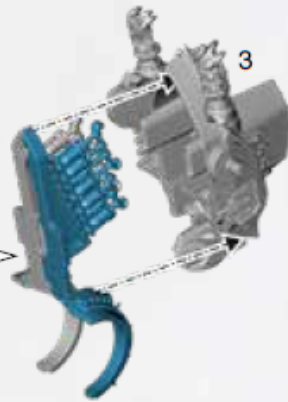
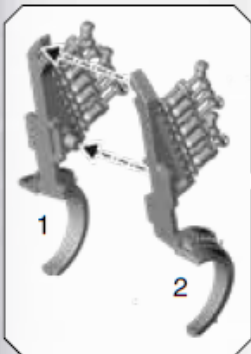

**3 b**

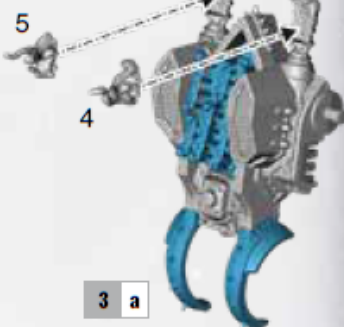

**3 c**

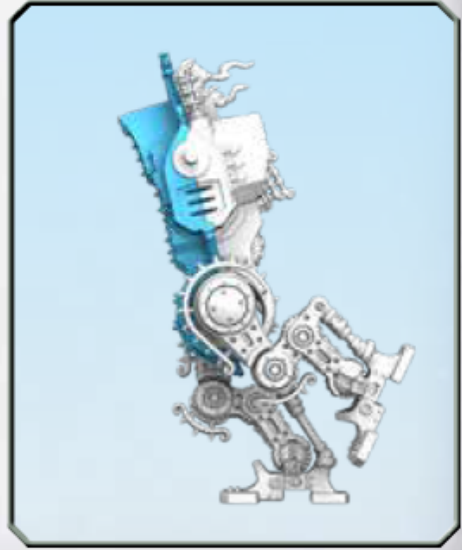
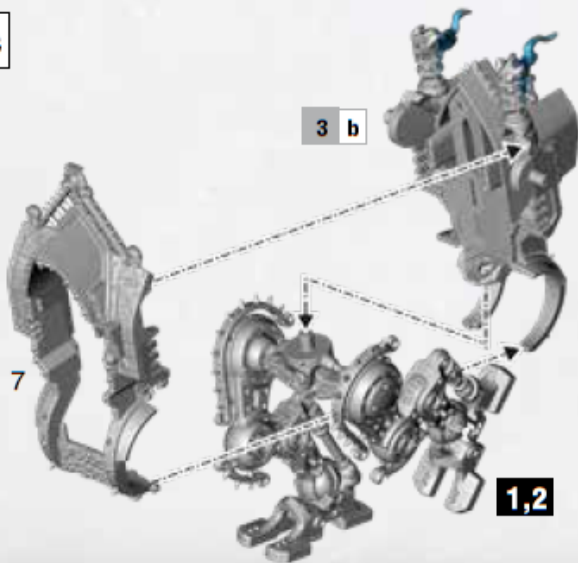

**3 d**

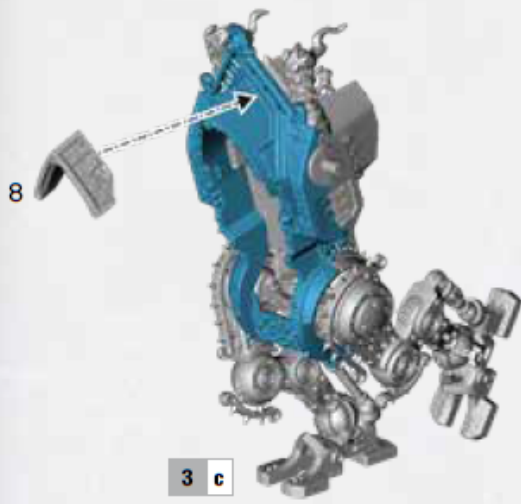

**3 e**

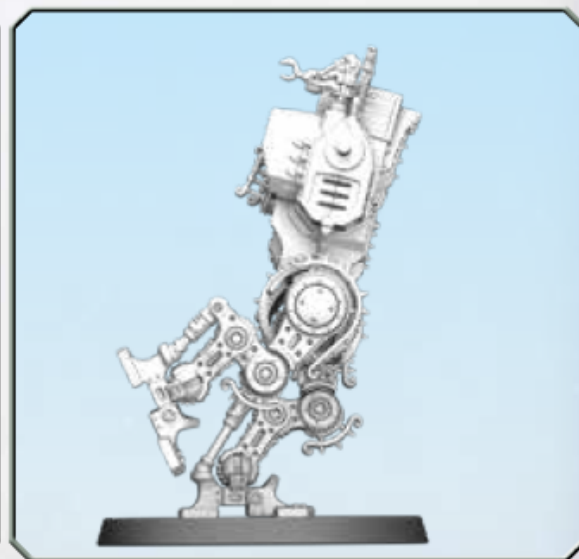

4

7

• INTERCHANGEABLE PARTS • ÉLÉMENTS INTERCHANGEABLES • PARTES INTERCAMBIABLES  
• AUSTAUSCHBARE TEILE • COMPONENTI INTERCAMBIABILI

PENITENT FLAIL • FLÉAU DE PÉNITENT • MAYAL DE PENITENTE • BÜSSER-FLEGEL • FLAGELLO DELLA PENITENTE

4

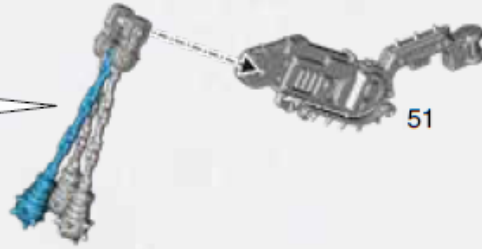

5

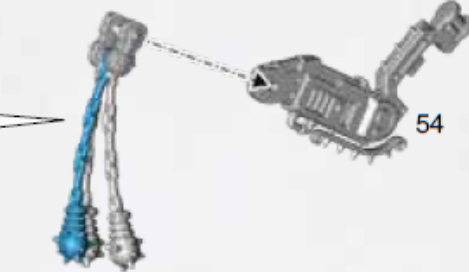
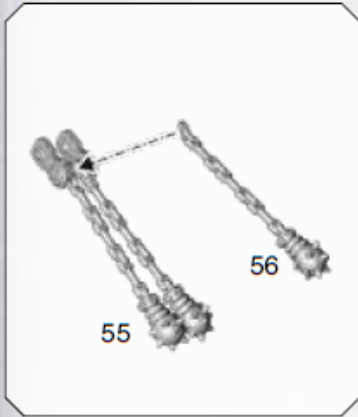

PENITENT BUZZ-BLADE • SCIE CIRCULAIRE DE PÉNITENT • SIERRA DE PENITENTE  
BÜSSER-KREISSÄGE • LAMA ROTANTE DELLA PENITENTE

6



7



· CHOOSE THE UNIT YOU WANT TO BUILD  
· CHOISISSEZ L'UNITÉ À ASSEMBLER · ESCOGE LA UNIDAD QUE QUIERES MONTAR  
· WÄHLE DIE EINHEIT, DIE DU BAUEN MÖCHTEST · SCEGLI L'UNITÀ CHE VUOI ASSEMBLARE

PENITENT ENGINES X 2

1 - 9 **x2**



PENITENT ENGINE & MORTIFER

1 - 11



MORTIFER X 2

1 - 7 & 9 - 11 **x2**



8 a

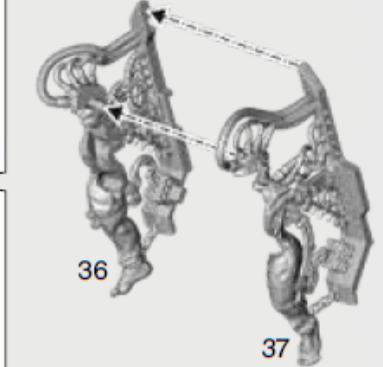
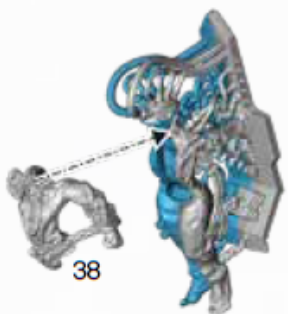
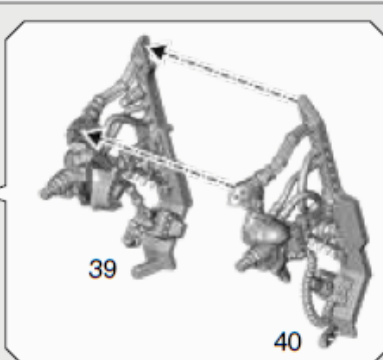
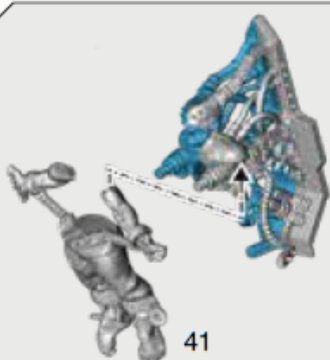

3

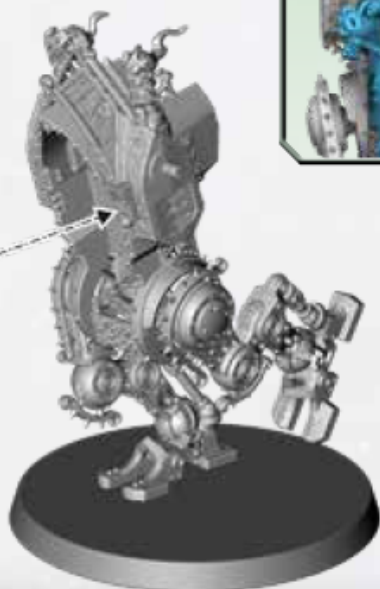

9 a 

FLAMER • LANCE-FLAMMES • LANZALLAMAS • FLAMMENWERFER • LANCIAFIAMME

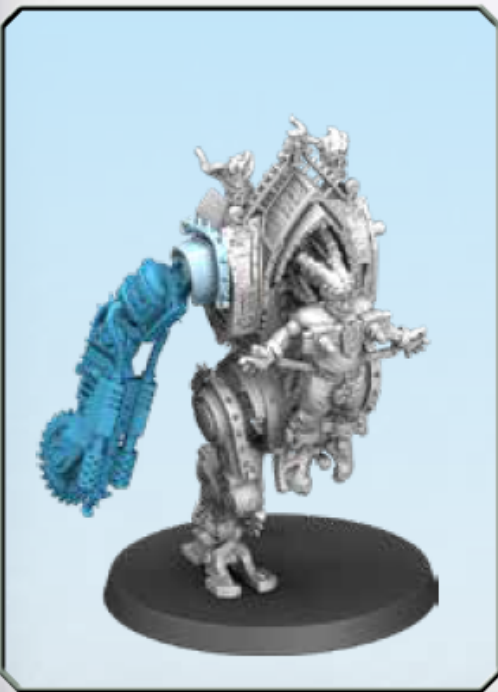
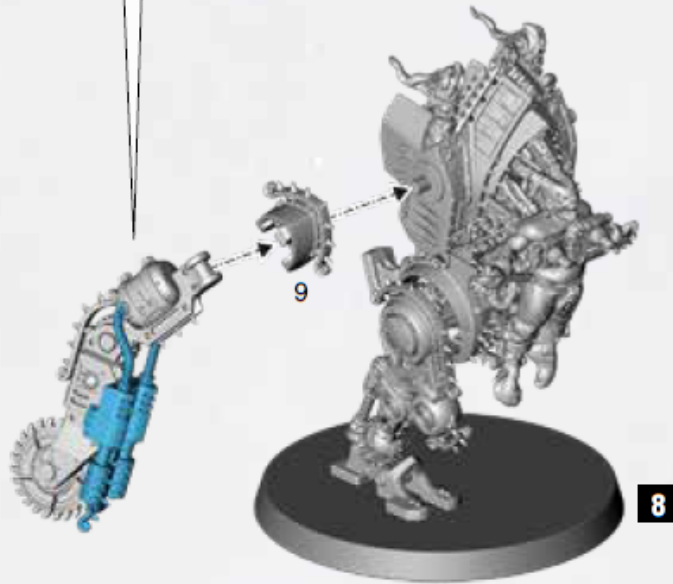
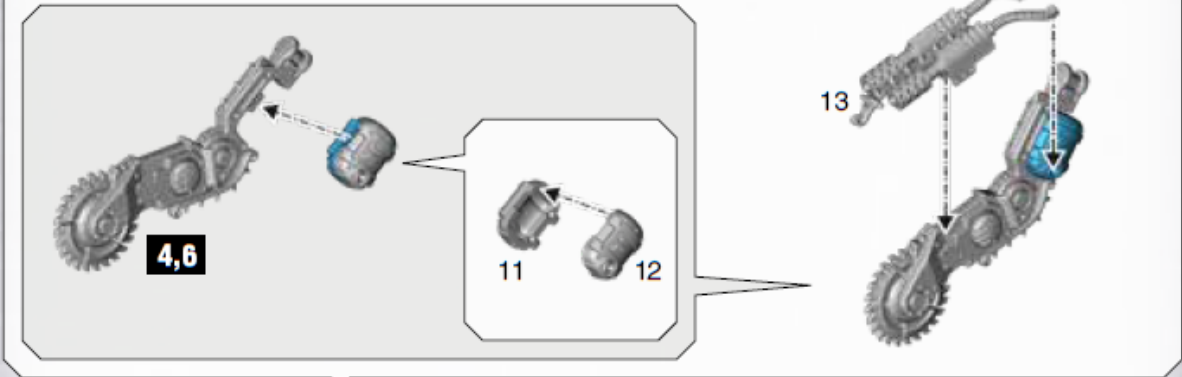

9

b



FLAMER • LANCE-FLAMMES • LANZALLAMAS • FLAMMENWERFER • LANCIAFIAMME

5,7



20

21



22

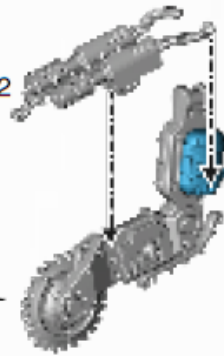

9 a

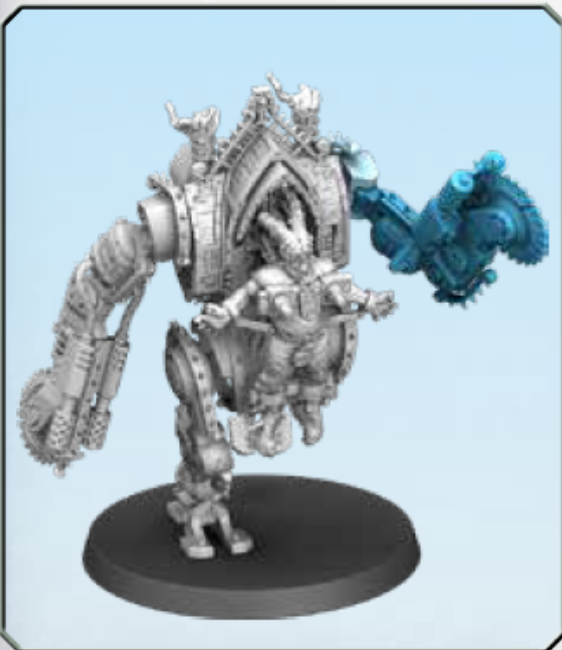
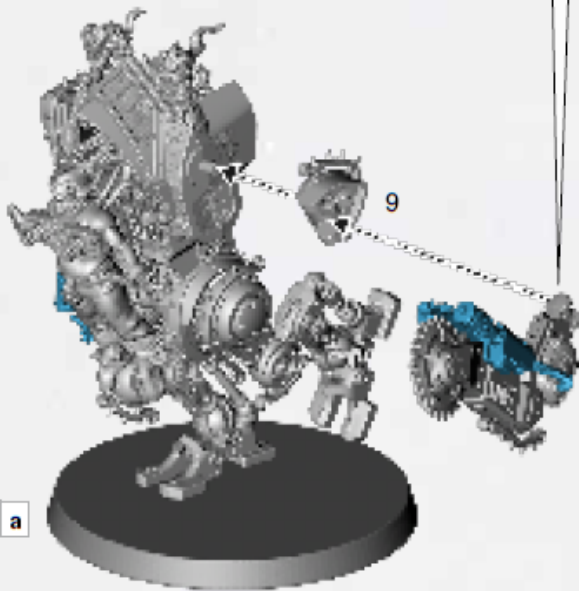



9 c



57



58



59



60



61



62



10 a

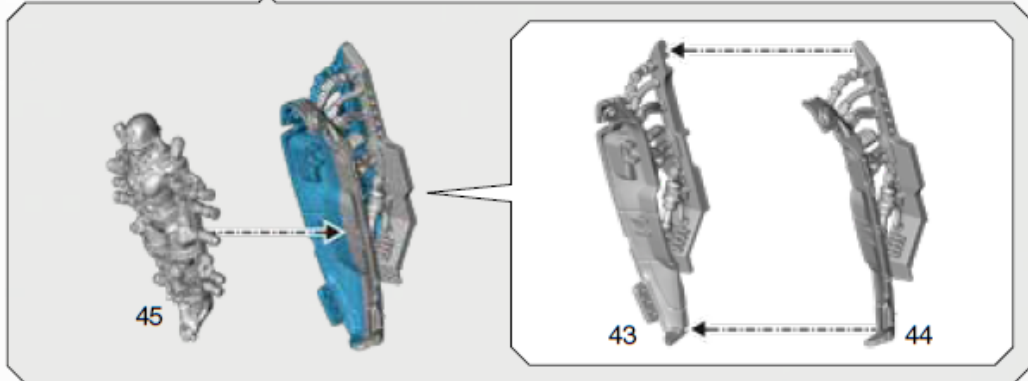
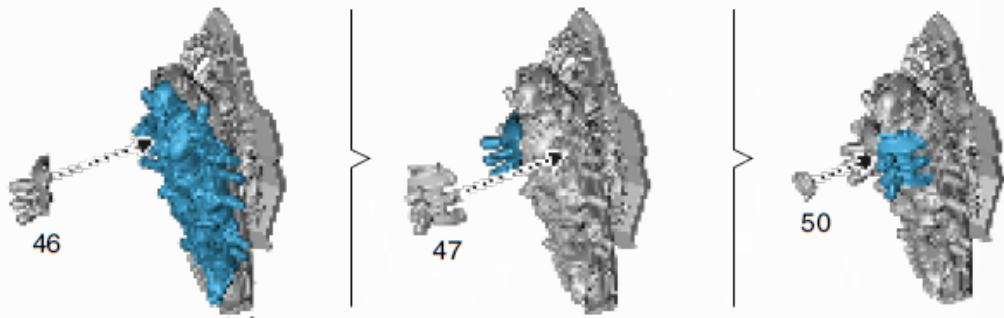

Anchorite

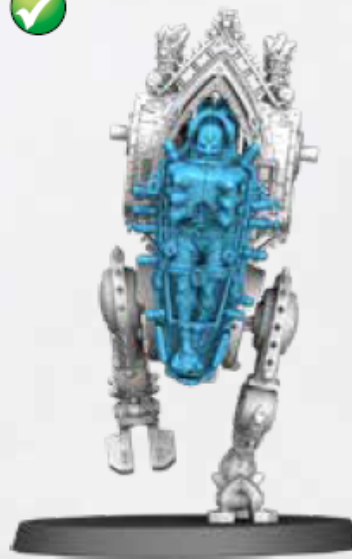
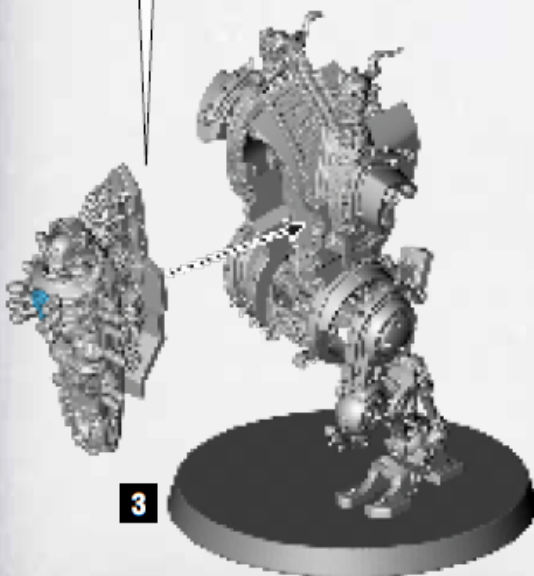
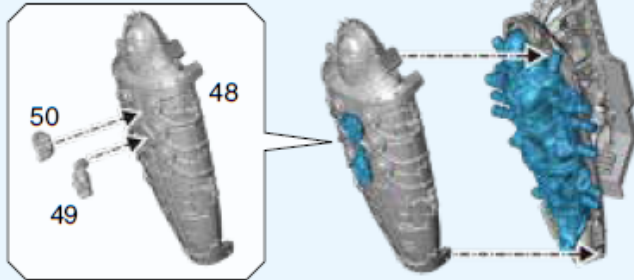

**11 a**

HEAVY BOLTER • BOLTER LOURD • BÓLTER PESADO • SCHWERER BOLTER • REQUIEM PESANTE

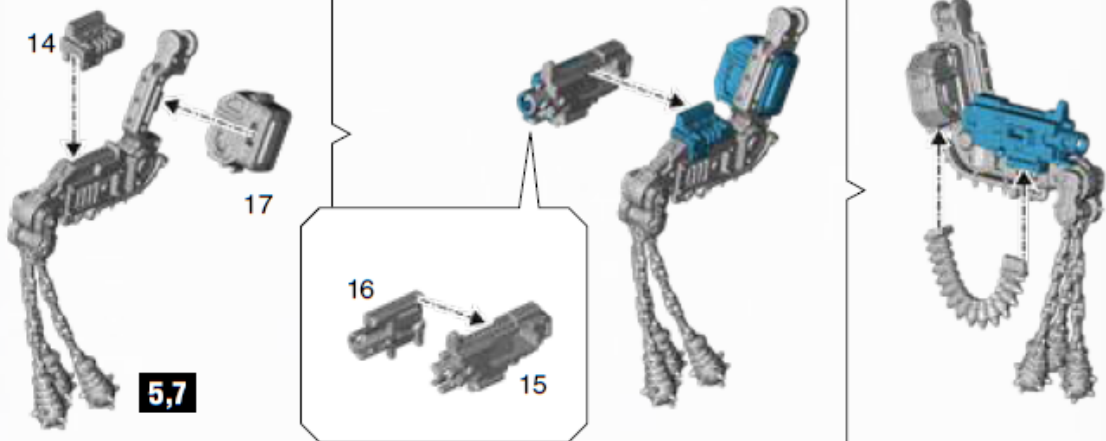

FLAMER • LANCE-FLAMMES • LANZALLAMAS • FLAMMENWERFER • LANCIAFIAMME

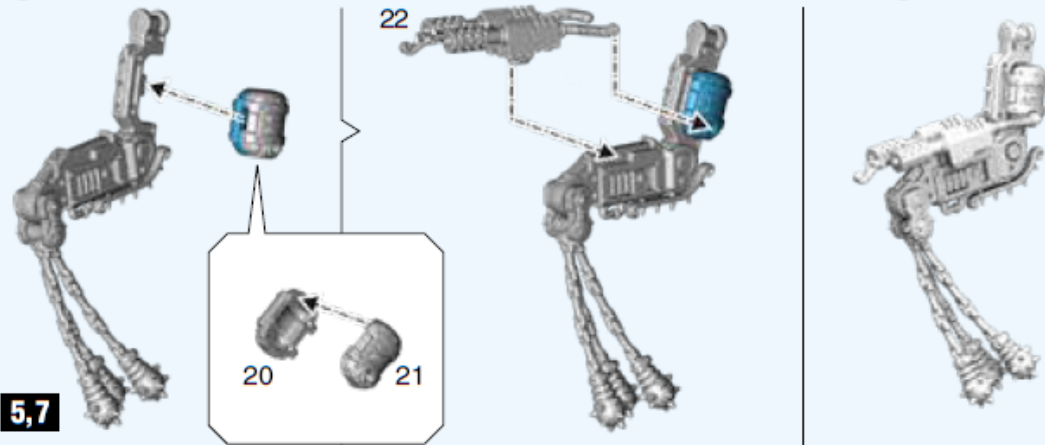

**11 b**

HEAVY BOLTER • BOLTER LOURD • BÓLTER PESADO • SCHWERER BOLTER • REQUIEM PESANTE

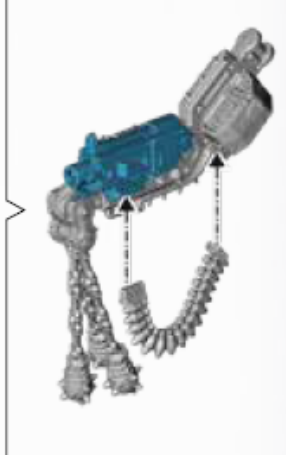
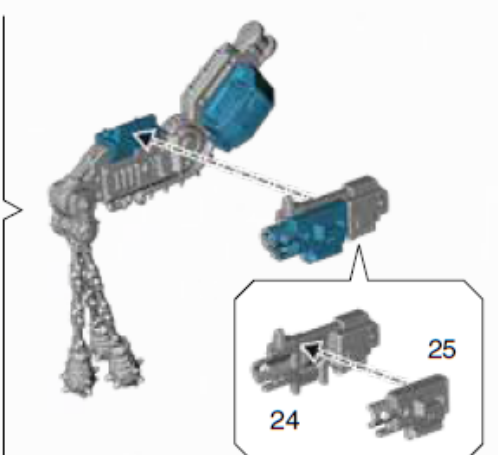
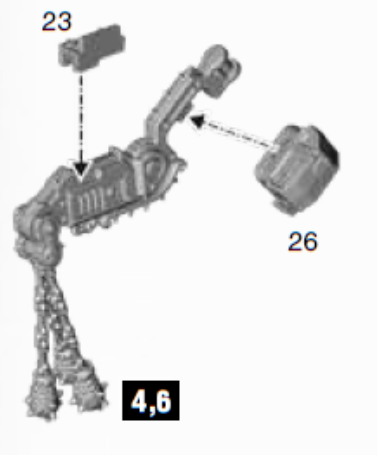

FLAMER • LANCE-FLAMMES • LANZALLAMAS • FLAMMENWERFER • LANCIAFIAMME

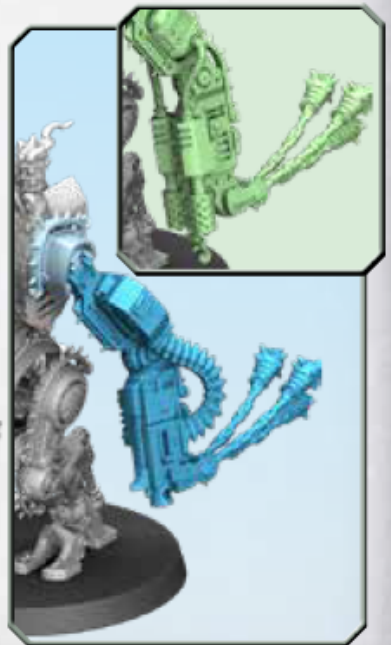
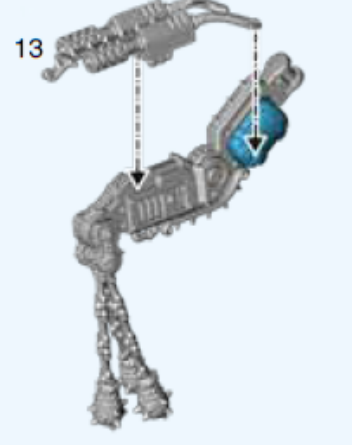
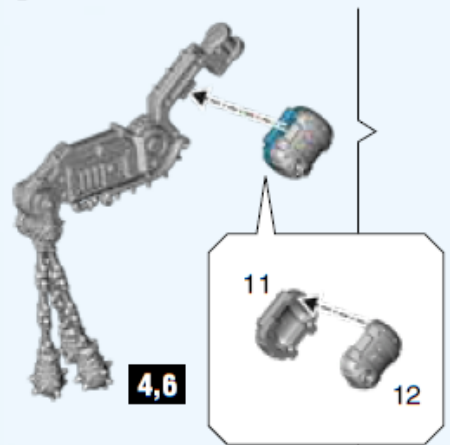

11 c

