

DEATH MASQUE



READ THIS FIRST • À LIRE EN PREMIER • LEER ANTES DE MONTAR • LIES DIES ZUERST • LEGGI PRIMA QUESTO

- Before assembling your model kit please read through the instructions in this booklet carefully. A pair of plastic cutters is required to remove the plastic components in this kit from their frame. We advise using a mouldline scraping tool to clean up the parts. To assemble your model you will need plastic glue. Games Workshop sells Citadel Fine Detail Cutters, Citadel Mouldline Remover and Citadel Plastic Glue, but does not recommend these products for use by children under the age of 16 without adult supervision.
- Avant de vous lancer dans l'assemblage de ce kit, veuillez lire attentivement les instructions de ce livret. Une pince coupante est requise pour détacher chaque élément de sa grappe. Nous vous recommandons l'utilisation d'un grattoir pour ébarber les éléments. Pour l'assemblage, vous aurez également besoin de colle plastique. Games Workshop commercialise les Pincas de Précision Citadel, l'Ébarboir Citadel et la Colle Plastique Citadel, mais n'en recommande pas l'utilisation pour des enfants de moins de 16 ans sans la supervision d'un adulte.
- Antes de montar el contenido de este kit, lee estas instrucciones cuidadosamente. Te harán falta unas tenazas para plástico a fin de separar las piezas de la matriz. También aconsejamos una herramienta para rebabas a fin de limpiar cada pieza. Para montar la miniatura necesitarás pegamento para plástico. Games Workshop vende Tenazas Citadel, Herramientas para rebabas Citadel y Pegamento para plástico Citadel, pero no recomienda estos productos a menores de 16 años sin la supervisión de un adulto.
- Bitte lies diese Anleitung sorgfältig, bevor du mit dem Zusammenbau deines Modells beginnst. Du benötigst einen Kunststoffseitenschneider, um die Kunststoffbauteile aus dem Gussrahmen herauszutrennen, und Kunststoffkleber, um die Miniatur zusammenzubauen. Außerdem empfehlen wir, die Bauteile vorher mit einem Gussgratentferner zu säubern. Games Workshop bietet Präzisions-Kunststoffseitenschneider von Citadel sowie Citadel-Kunststoffkleber an, empfiehlt aber, dass Kinder unter 16 Jahren diese nur unter Aufsicht eines Erwachsenen benutzen.
- Prima di assemblare il tuo modello, leggi le istruzioni di questo libretto con attenzione. Sono necessarie un paio di tronchesine per plastica per staccare i componenti dai loro sprue. Consigliamo di usare un attrezzo apposito per pulire i componenti. Per assemblare il modello avrai bisogno di colla per plastica. Games Workshop vende Tronchesine di precisione Citadel, Attrezzo per ripulire Citadel e Colla per plastica Citadel, ma non consiglia questi prodotti ad un pubblico minore di 16 anni senza la supervisione di un adulto.

Explanation of symbols • Explication des symboles • Explicación de símbolos • Erläuterung der symbole • Legenda dei simboli

- | | | |
|--|--|---|
|  <ul style="list-style-type: none"> • Special instruction - Please read • Instructions spéciales - Lire attentivement • Instrucción especial: Por favor, léela • Besondere Anweisung - Bitte lesen • Istruzioni speciali - Leggi attentamente |  <ul style="list-style-type: none"> • Choice of parts • Choix d'éléments • Modelos de componentes • Auswahl an Teilen • Scelta di componenti |  <ul style="list-style-type: none"> • Repeat process • Répéter l'étape • Repetir pasos • Vorgang wiederholen • Ripeti il processo |
|  <ul style="list-style-type: none"> • Dry fit stage before gluing • Tester avant de coller • Comprobar el encaje antes de pegar • Positionierung erst ohne Klebstoff ausprobieren • Prova a secco prima di incollare |  <ul style="list-style-type: none"> • Variant assembly • Variante d'assemblage • Variante de montaje • Bauvariante • Assemblaggio alternativo |  <ul style="list-style-type: none"> • Rotate part • Faire pivoter • Girar la pieza • Teil drehen • Ruota il componente |
|  <ul style="list-style-type: none"> • Paint before assembly • Peindre avant assemblage • Pintar antes del montaje • Erst bemalen, dann zusammenbauen • Dipingi prima dell'assemblaggio |  <ul style="list-style-type: none"> • Detail view • Vue détaillée • Vista detallada • Alternative Ansicht • Visuale del dettaglio |  <ul style="list-style-type: none"> • Stage complete • Étape terminée • Paso completado • Schritt abgeschlossen • Fase completa |
|  <ul style="list-style-type: none"> • Do not glue the components • Ne pas coller les éléments • No pegar los componentes • Bitte die Teile nicht kleben • Non incollare i componenti |  <ul style="list-style-type: none"> • Assembly sequence • Séquence d'Assemblage • Secuencia de montaje • Baureihenfolge • Sequenza di assemblaggio | |

16+



- Citadel plastic glue thick
- Colle plastique épaisse Citadel
- Pegamento para plástico espeso
- Citadel-kunststoffkleber (Dickflüssig)
- Colla per plastica densa Citadel

- Citadel plastic glue thin
- Colle plastique liquide Citadel
- Pegamento para plástico fluido
- Citadel-kunststoffkleber (Dünnflüssig)
- Colla per plastica fluida Citadel

- Citadel fine detail cutters
- Pincas de precisión Citadel
- Tenazas Citadel
- Präzisions-kunststoffseitenschneider
- Tronchesine di precisione Citadel

- Citadel mouldline remover
- Ébarboir Citadel
- Herramienta para rebabas Citadel
- Gussgratentferner
- Attrezzo per ripulire Citadel

1 ELDRAD ULTHRAN

1 a

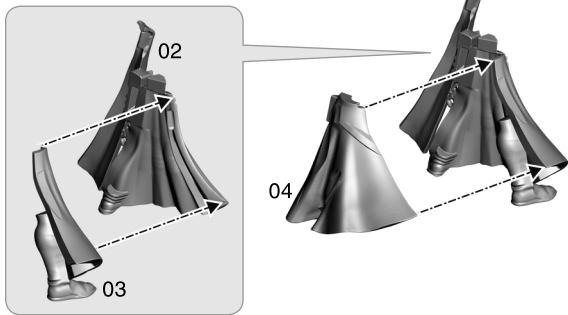

1 b

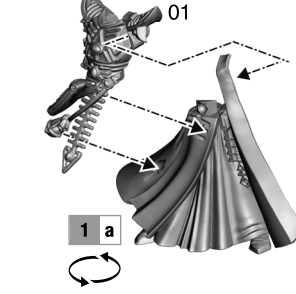

1 c



1 d

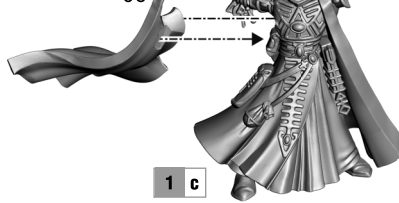

1 e

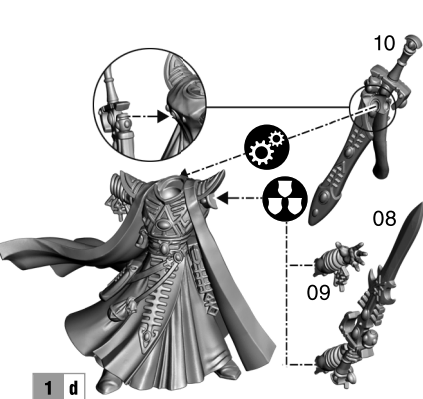

1 f

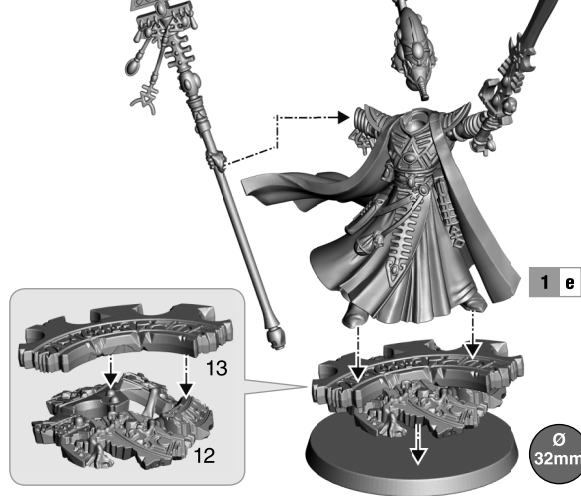

2 DEATH JESTER

2

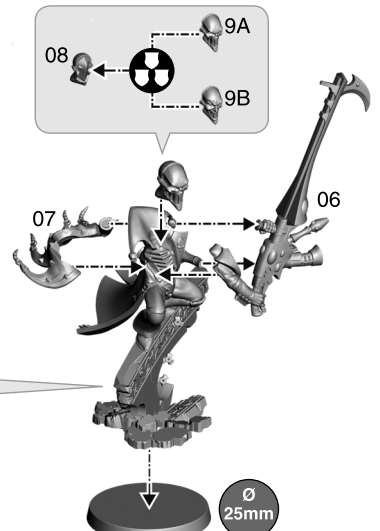
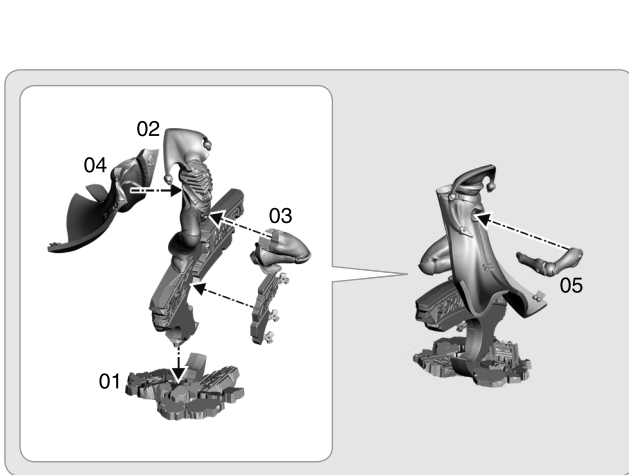

3 a HARLEQUIN TROUPE MASTER

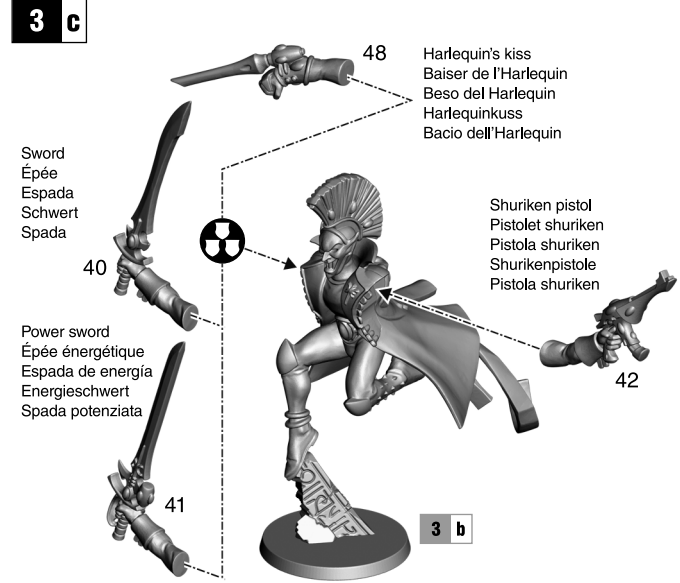
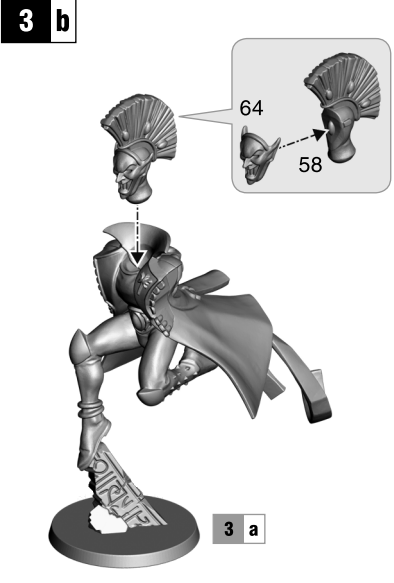
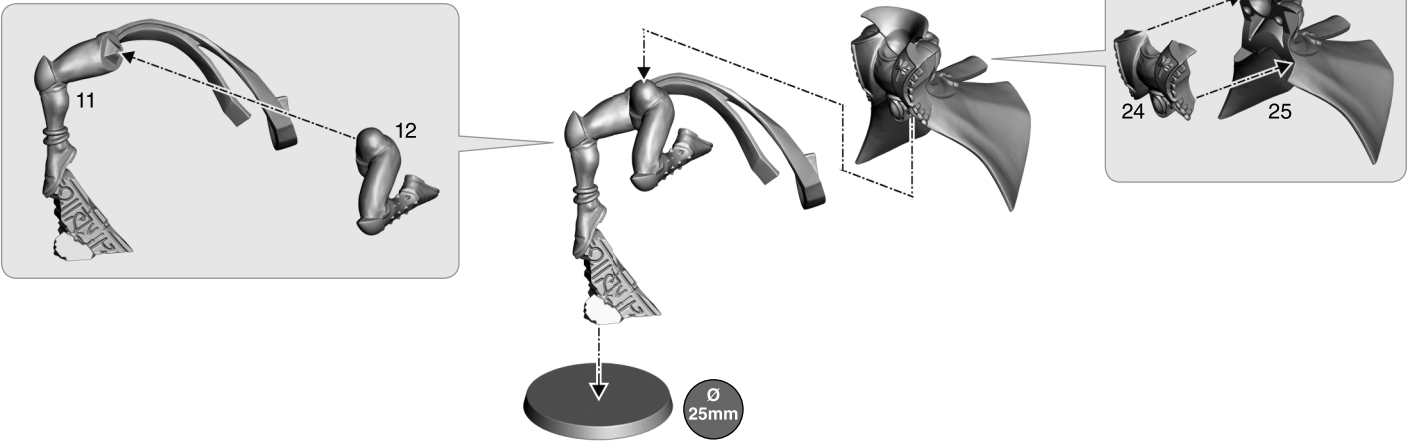

4 a INTERCHANGEABLE PARTS • ÉLÉMENTS INTERCHANGEABLES • PARTES INTERCAMBIABLES • AUSTAUSCHBARE TEILE • COMPONENTI INTERCAMBIABILI

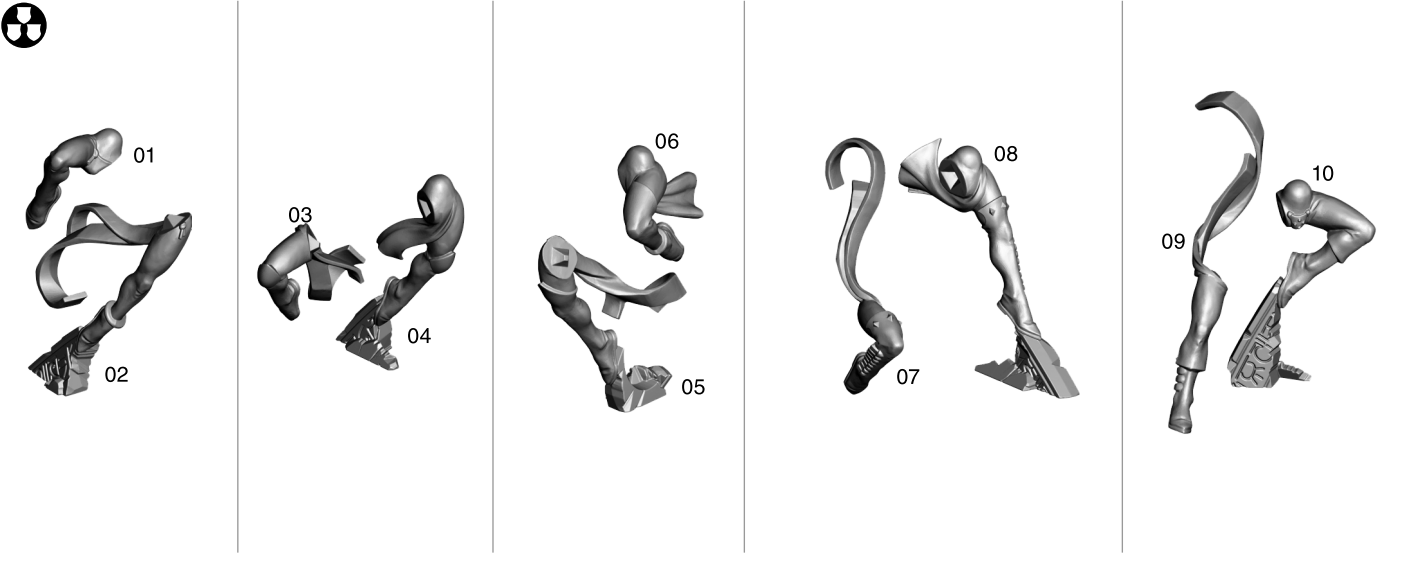

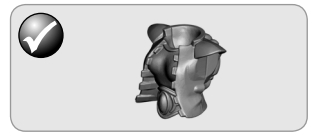
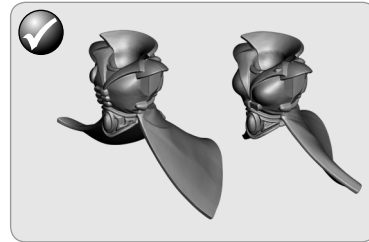
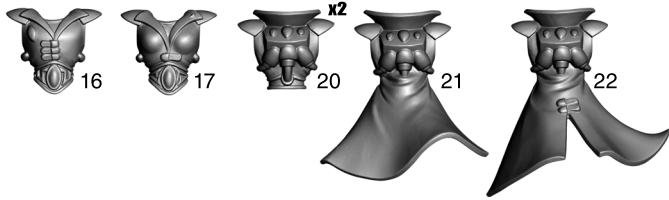
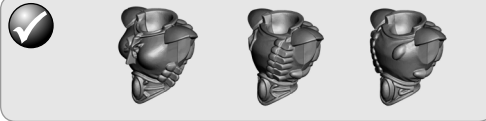
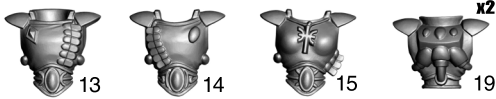
4 b**4 c**

Heads with pre-fitted masks
Têtes masquées
Cabezas con máscara incluida
Einteilige Köpfe mit Masken
Teste complete di maschera

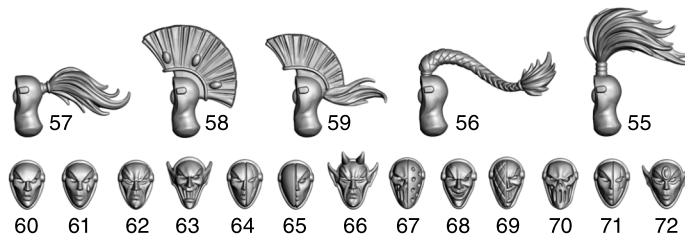
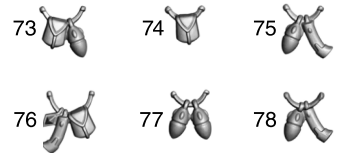
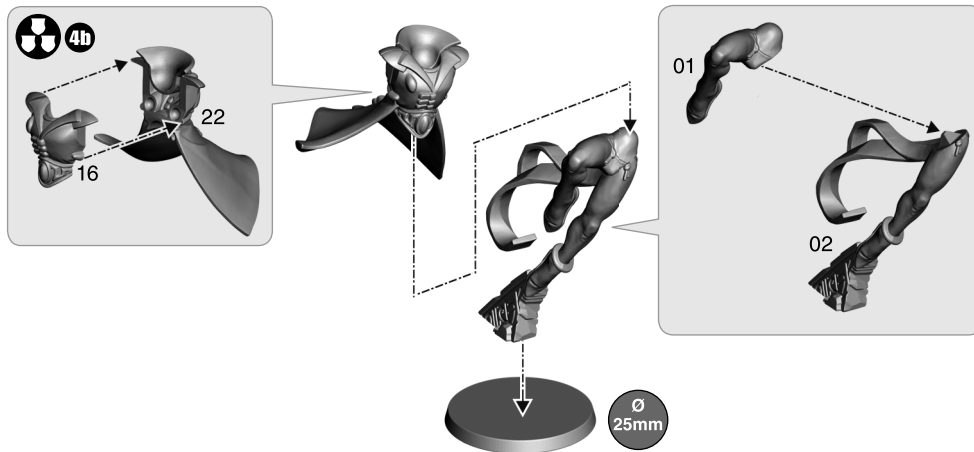
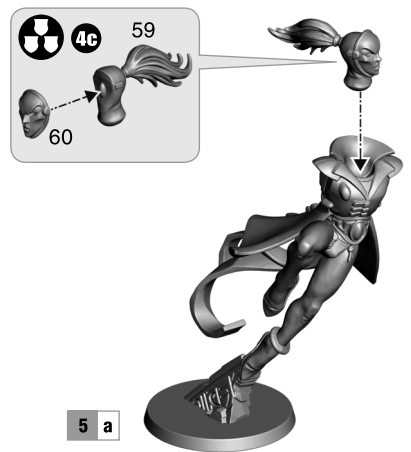
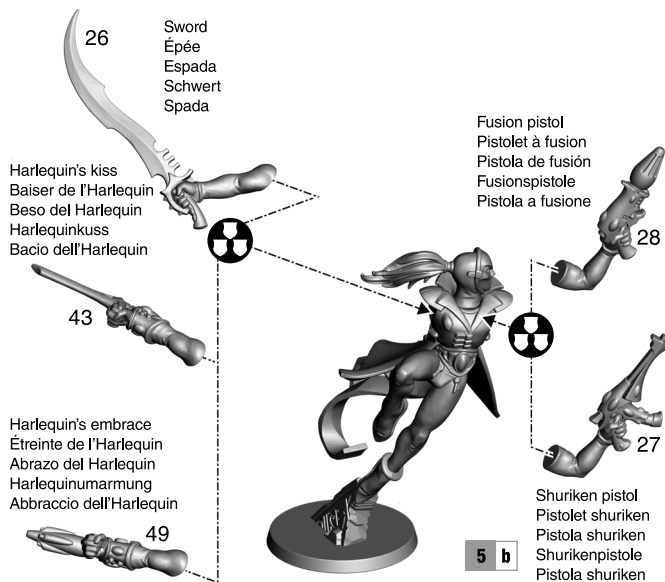
**4 d****5 a****HARLEQUIN PLAYER 1****5 b****5 c**

6 a HARLEQUIN PLAYER 2

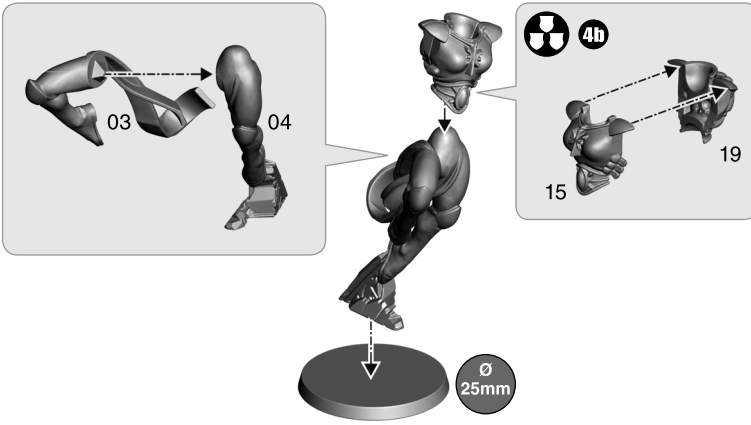

6 b

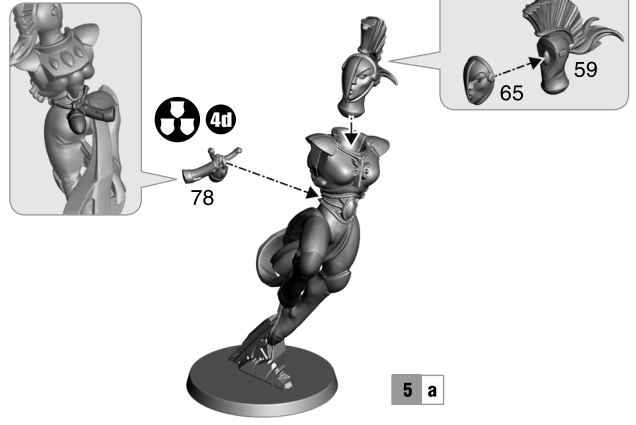

6 c

Sword
Epée
Espada
Schwert
Spada



34

Fusion pistol
Pistolet à fusion
Pistola de fusión
Fusionspistole
Pistola a fusione



36



46

Harlequin's kiss
Baiser de l'Harlequin
Beso del Harlequin
Harlequinkuss
Bacio dell'Harlequin

6 b

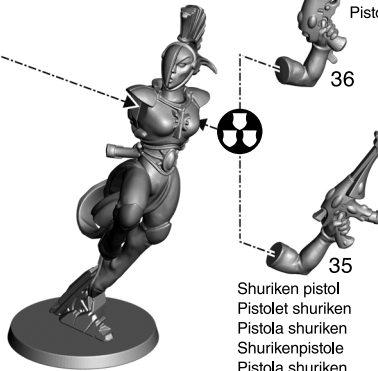

Shuriken pistol
Pistolet shuriken
Pistola shuriken
Shurikenpistole
Pistola shuriken

35



7 a HARLEQUIN PLAYER 3

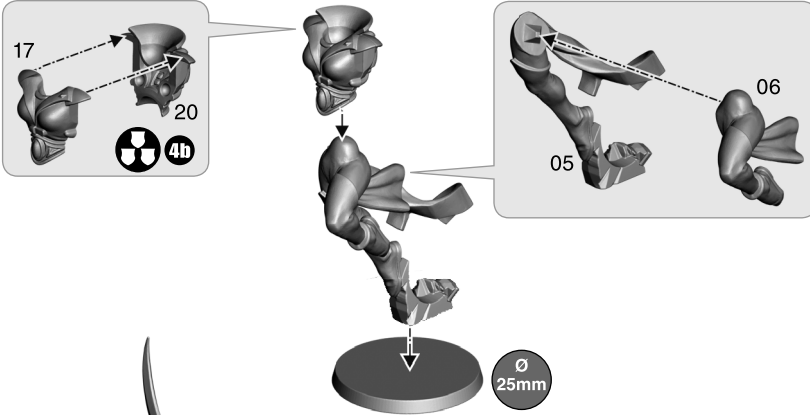

7 b

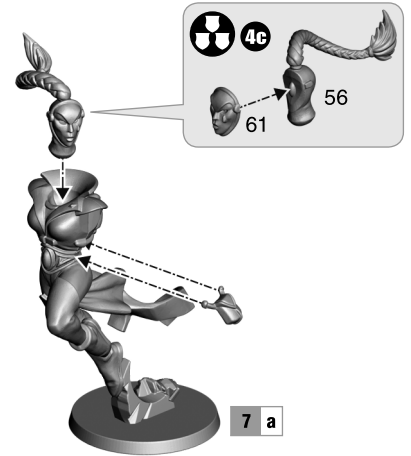

7 c

Sword
Epée
Espada
Schwert
Spada



31

Neuro disruptor
Neuro-disrupteur
Neuro Disruptor
Neurodisruptore



33

Harlequin's kiss
Baiser de l'Harlequin
Beso del Harlequin
Harlequinkuss
Bacio dell'Harlequin

45



7 b

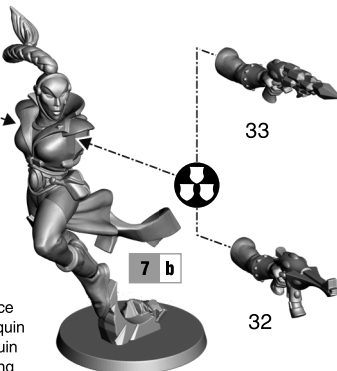

Shuriken pistol
Pistolet shuriken
Pistola shuriken
Shurikenpistole
Pistola shuriken

32

Harlequin's embrace
Étreinte de l'Harlequin
Abrazo del Harlequin
Harlequinarmung
Abbraccio dell'Harlequin

50



8 a HARLEQUIN PLAYER 4

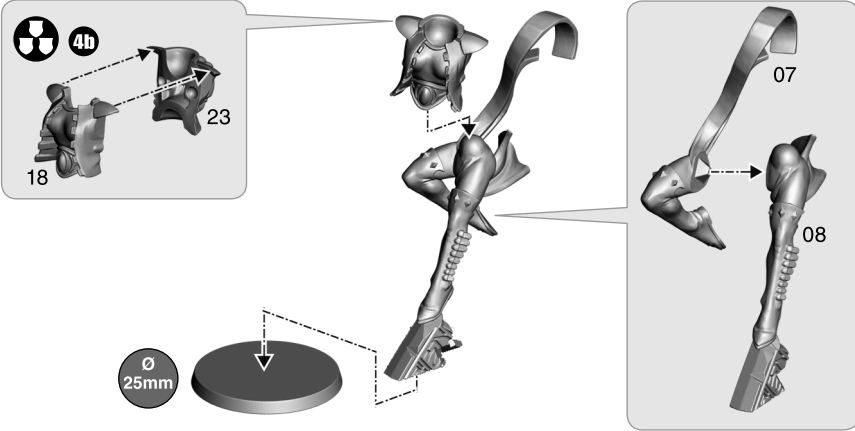

8 b

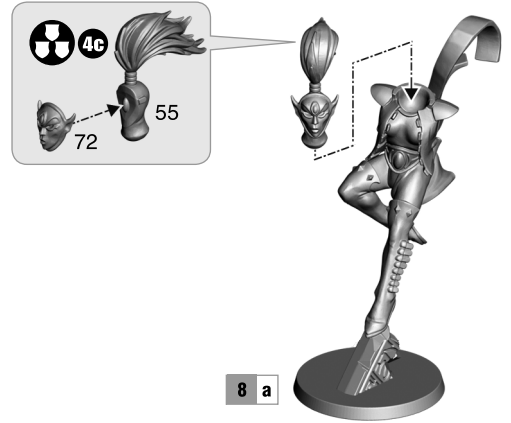

8 c

Harlequin's caress
Caresse de l'Harlequin
Caricia del Harlequin
Harlequinliebkosung
Carezza dell'Harlequin

Harlequin's kiss
Baiser de l'Harlequin
Beso del Harlequin
Harlequinkuss
Bacio dell'Harlequin

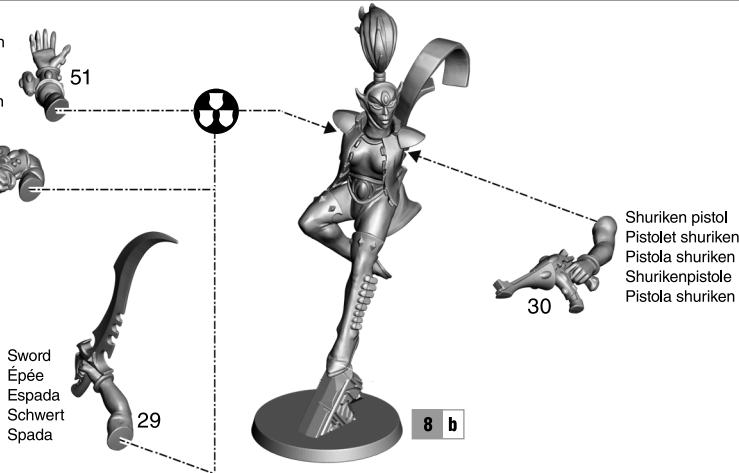

Shuriken pistol
Pistolet shuriken
Pistola shuriken
Shurikenpistole
Pistola shuriken

Sword
Épée
Espada
Schwert
Spada



9 a HARLEQUIN PLAYER 5

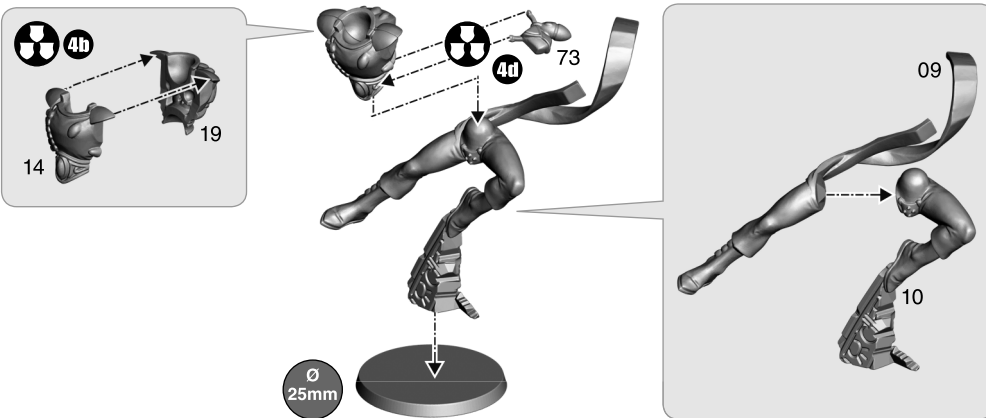

9 b

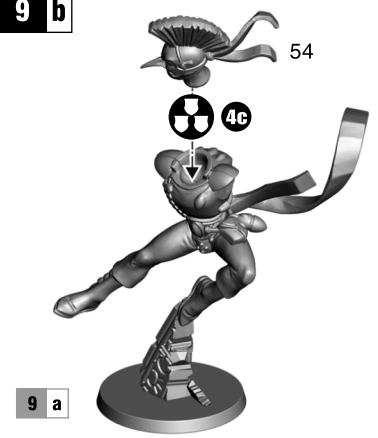

9 c

Sword
Épée
Espada
Schwert
Spada

Harlequin's kiss
Baiser de l'Harlequin
Beso del Harlequin
Harlequinkuss
Bacio dell'Harlequin

Harlequin's caress
Caresse de l'Harlequin
Caricia del Harlequin
Harlequinliebkosung
Carezza dell'Harlequin

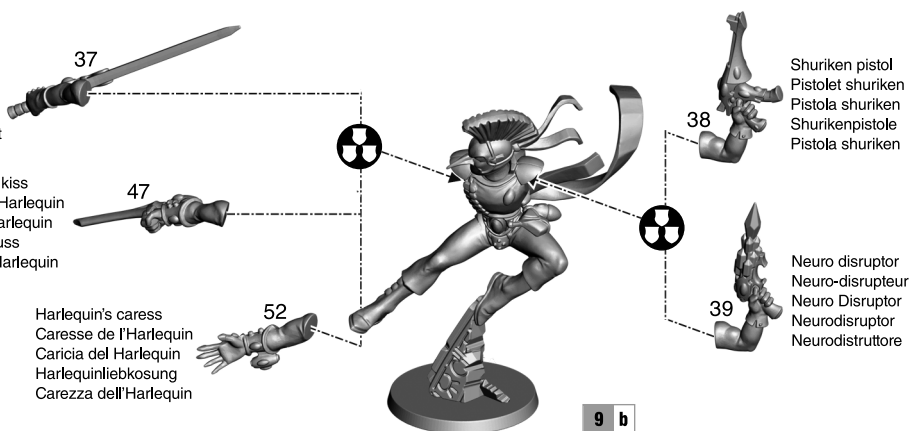

Shuriken pistol
Pistolet shuriken
Pistola shuriken
Shurikenpistole
Pistola shuriken

Neuro disruptor
Neuro-disrupteur
Neuro Disruptor
Neurodisruptore
Neurodistruttore

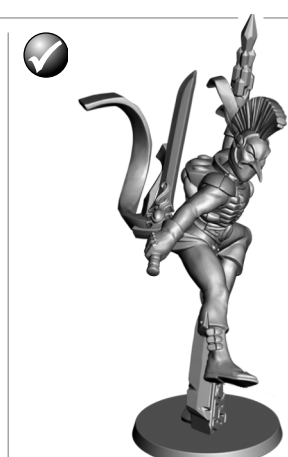

10 - 16 STARWEAVER & VOIDWEAVER

Follow steps 10 & 11 for all variants • Suivre les étapes 10 & 11 pour tous les variantes • Sigue los pasos 10 y 11 para todas las versiones • Folge den Schritten 10 & 11 für alle Varianten • Segui le fasi 10 e 11 per tutte le varianti

10 a

x2

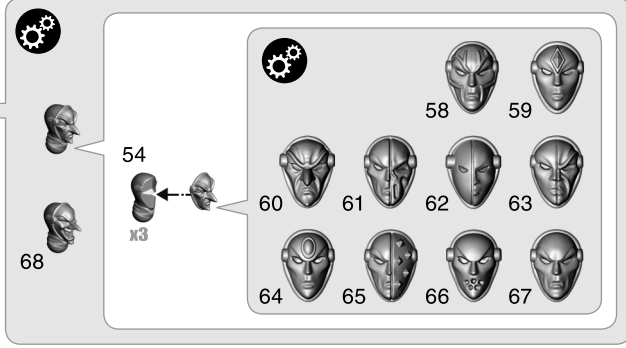
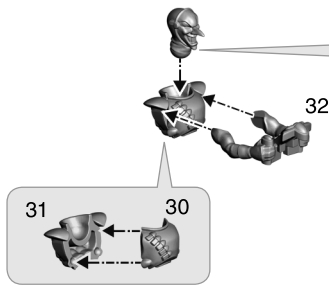

10 b

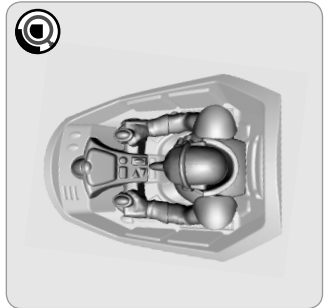
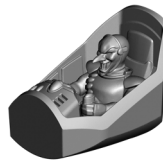
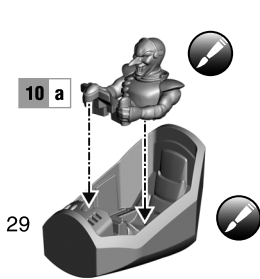

11 a

x2

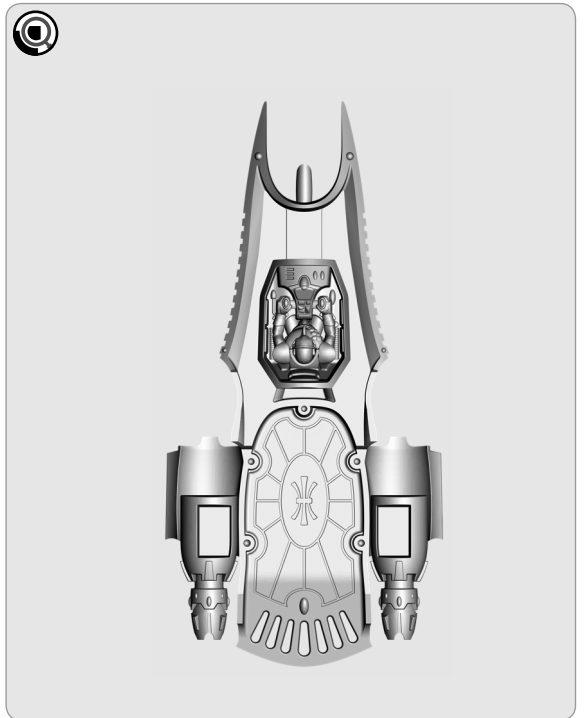
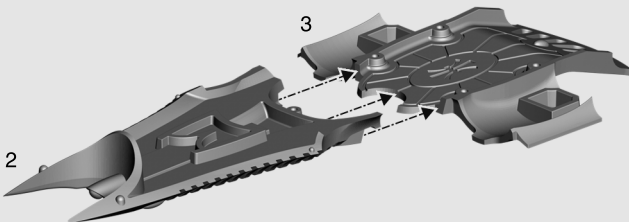
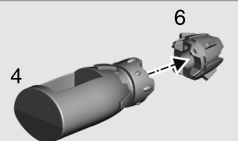
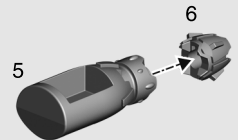
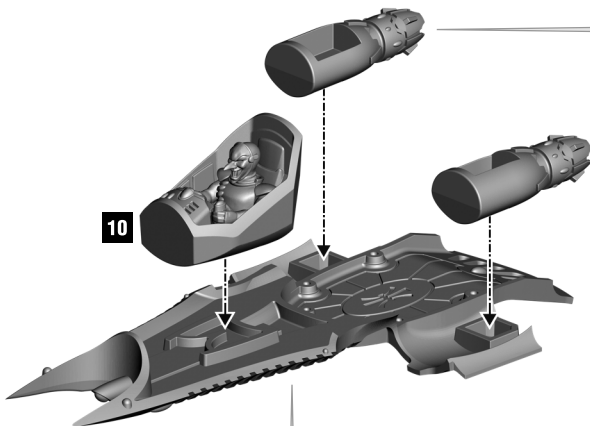

11 b

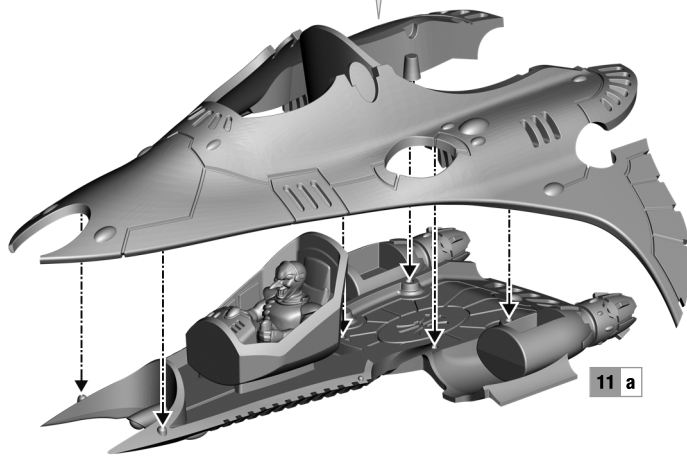
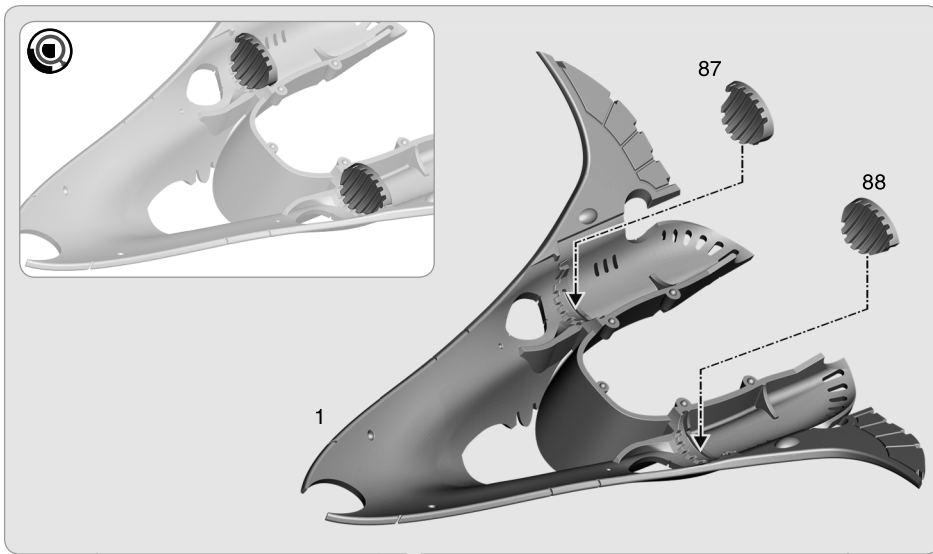

11 c

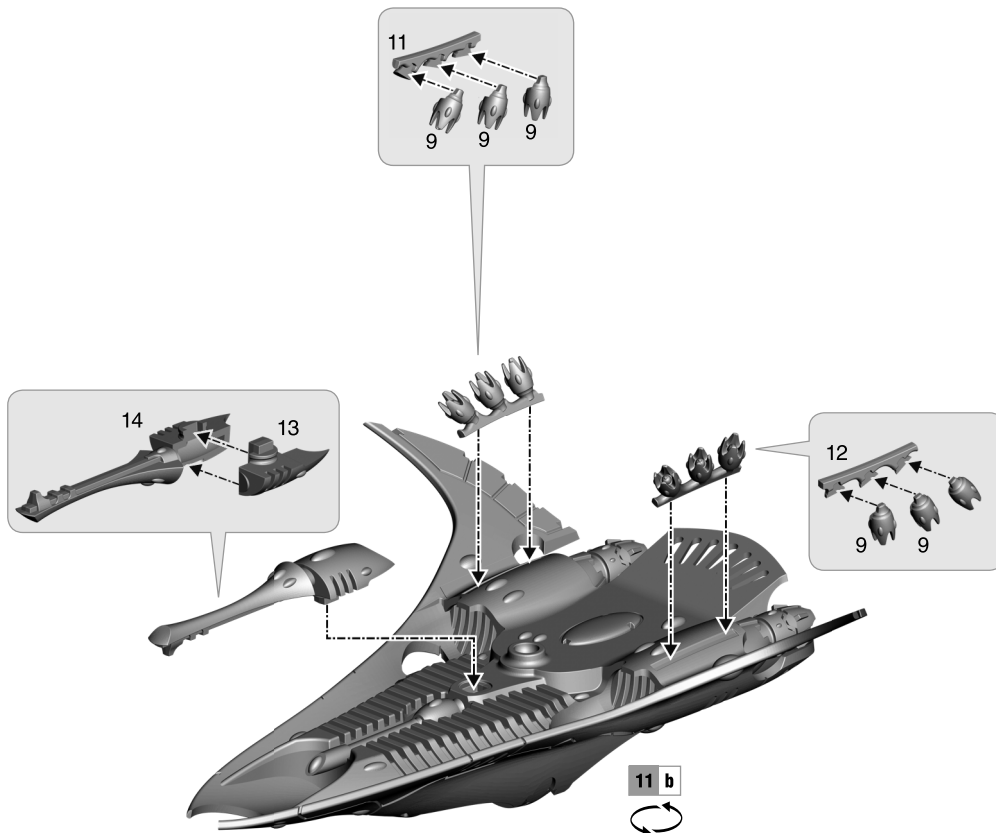

11 d

11 c

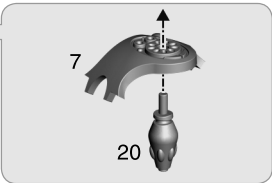
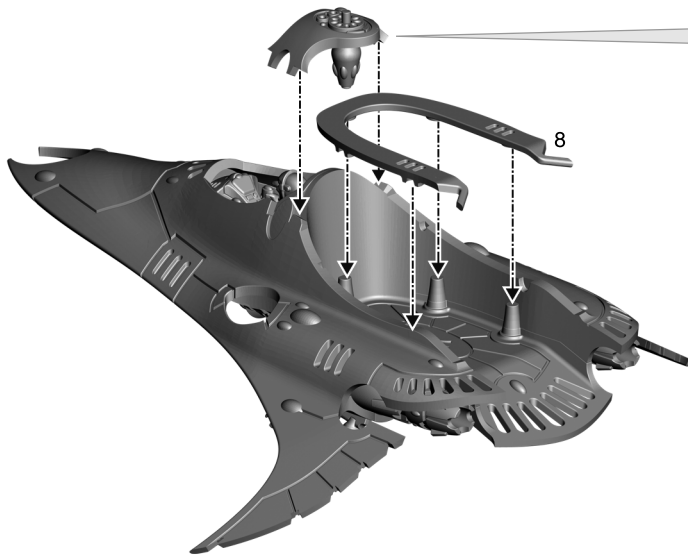

11 e



11 d

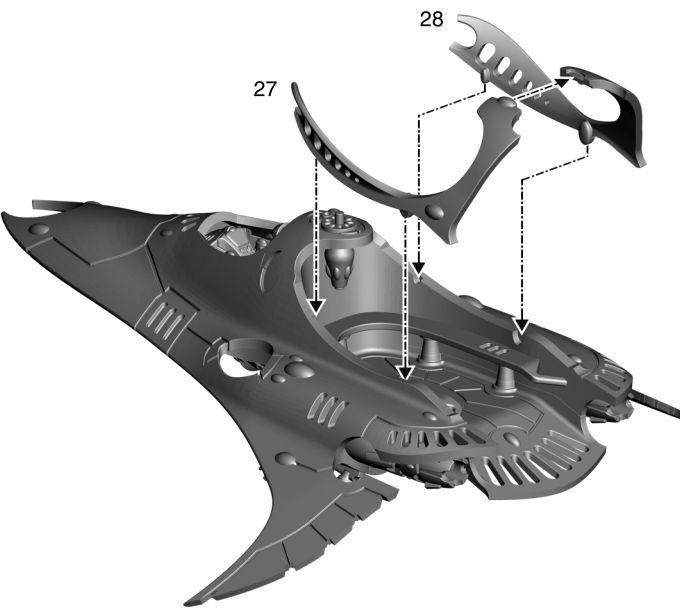

11 f



11 e

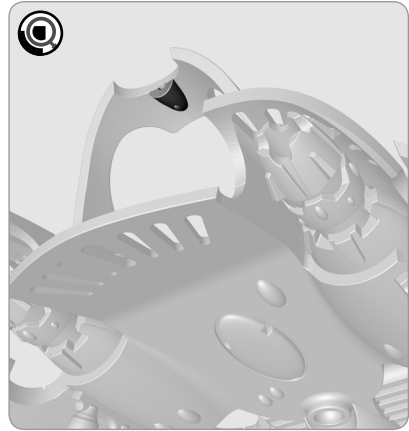
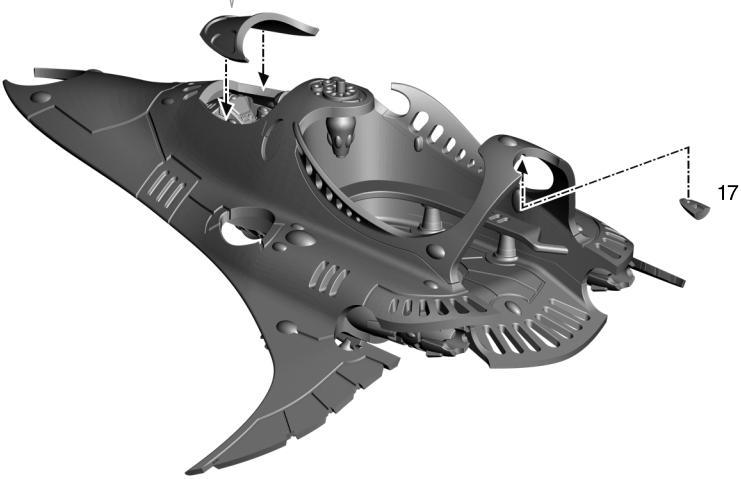

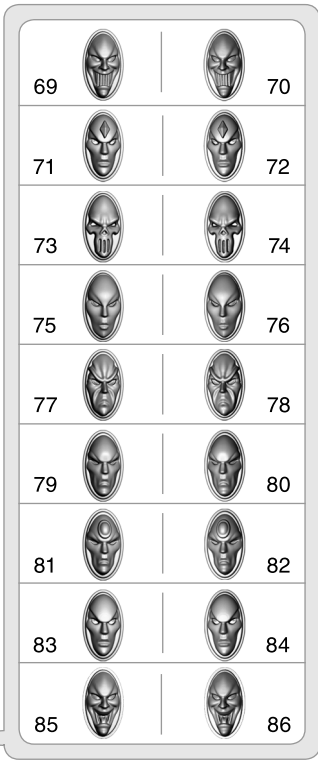

Hull masks are designed to apply as a pair. However, the left and right masks are not interchangeable.

Ces masques sont conçus pour être utilisés par paire, mais les masques droits et gauches ne sont pas interchangeables.

Las máscaras se utilizan por parejas, pero las del lado izquierdo y el derecho no son intercambiables.

Die Ziermasken sind paarweise gestaltet. Die rechten und linken Masken sind jedoch nicht austauschbar.

Le maschere dello scafo sono ideate per essere applicate in coppia. Tuttavia, le maschere di destra e di sinistra non sono intercambiabili.

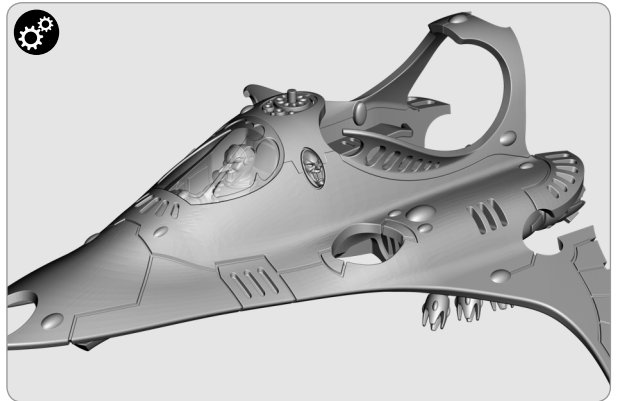
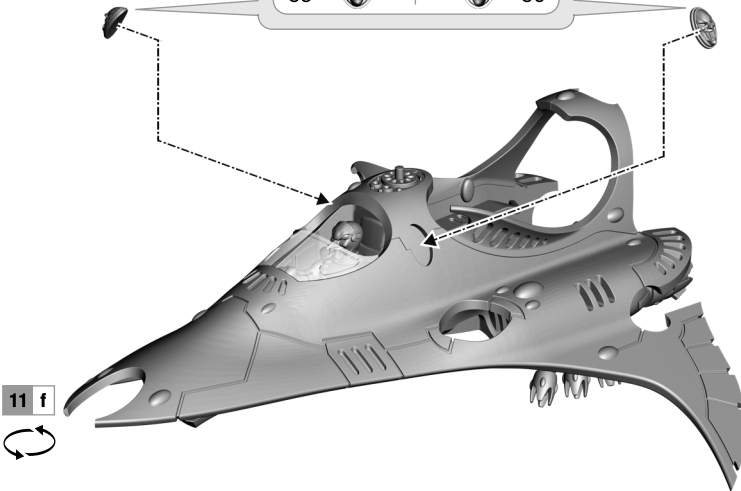

12 a

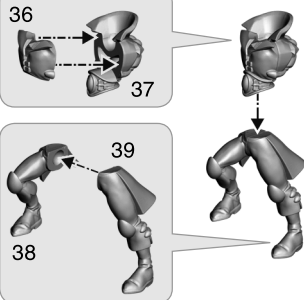

12 b

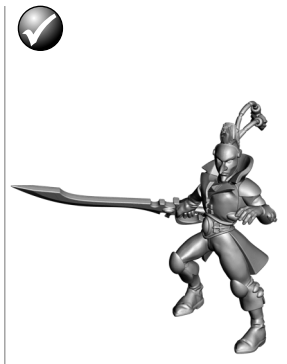
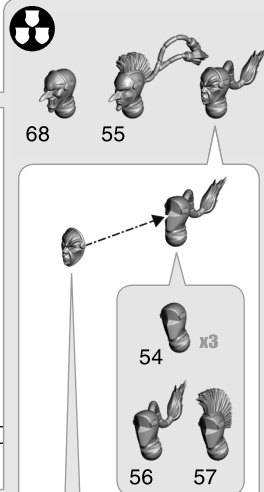
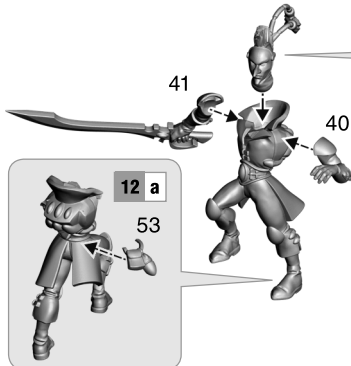

13 a

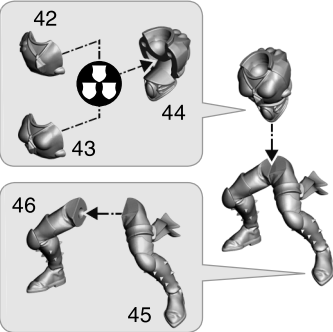

13 b

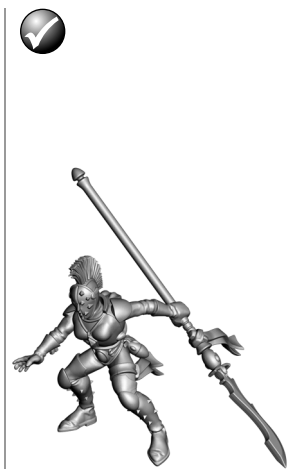
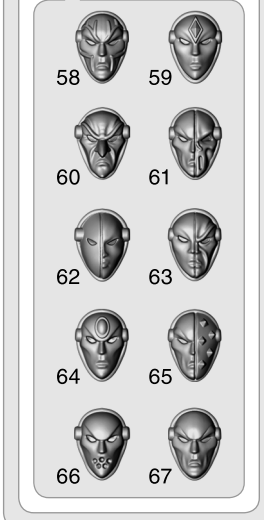
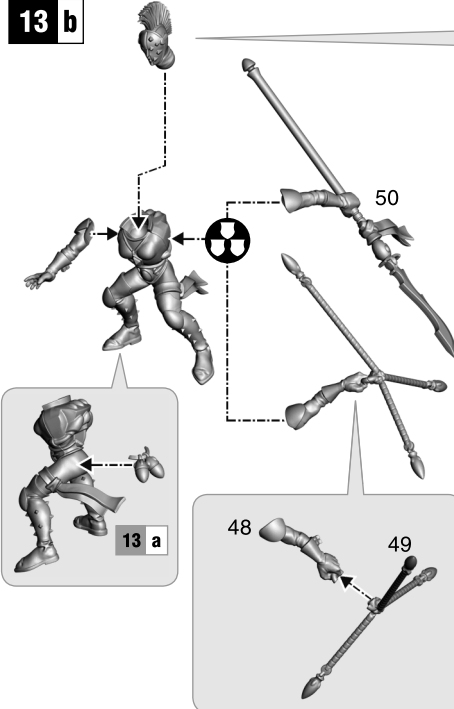

14 a

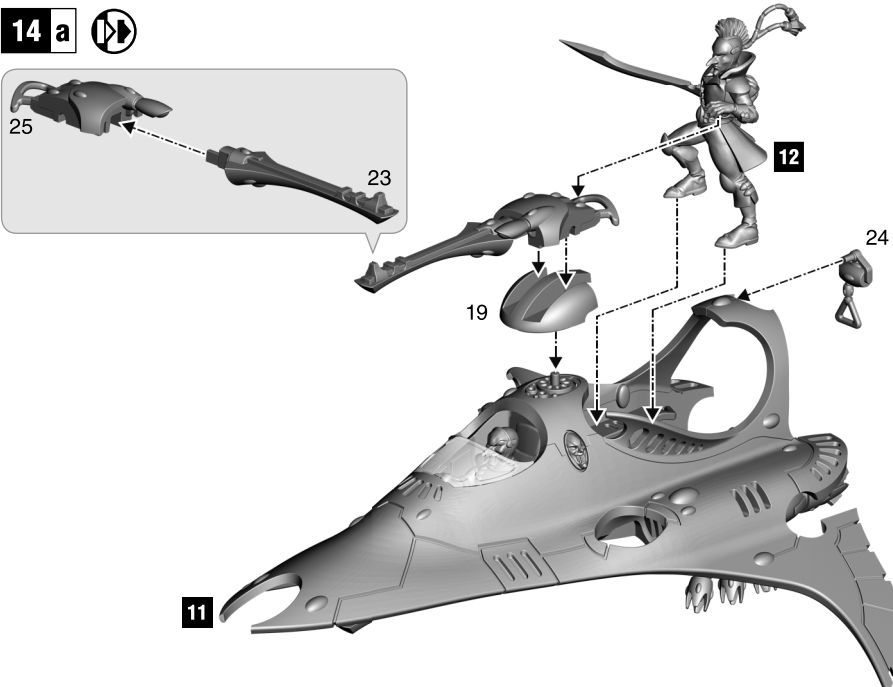

14 b

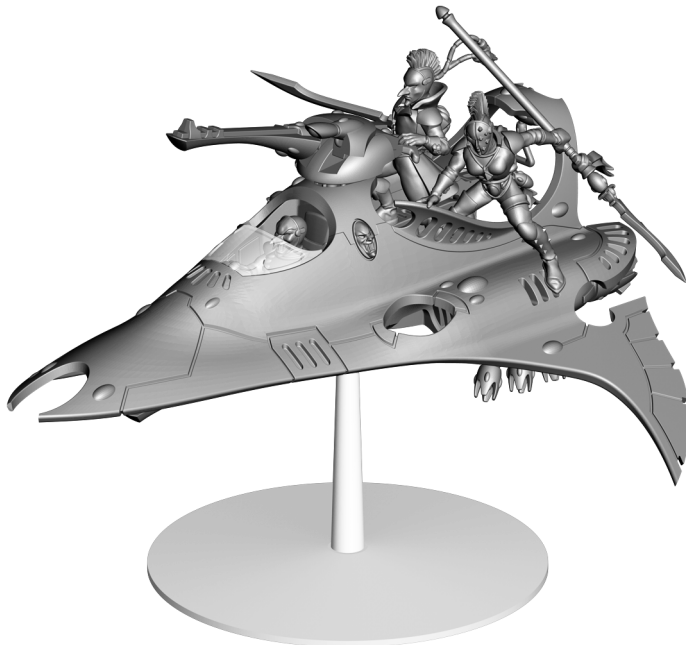
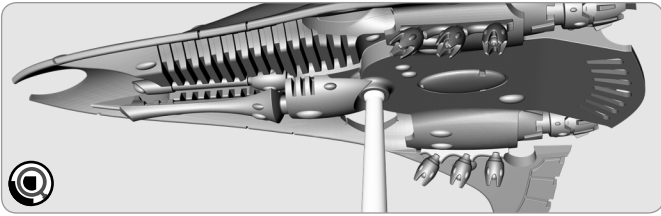
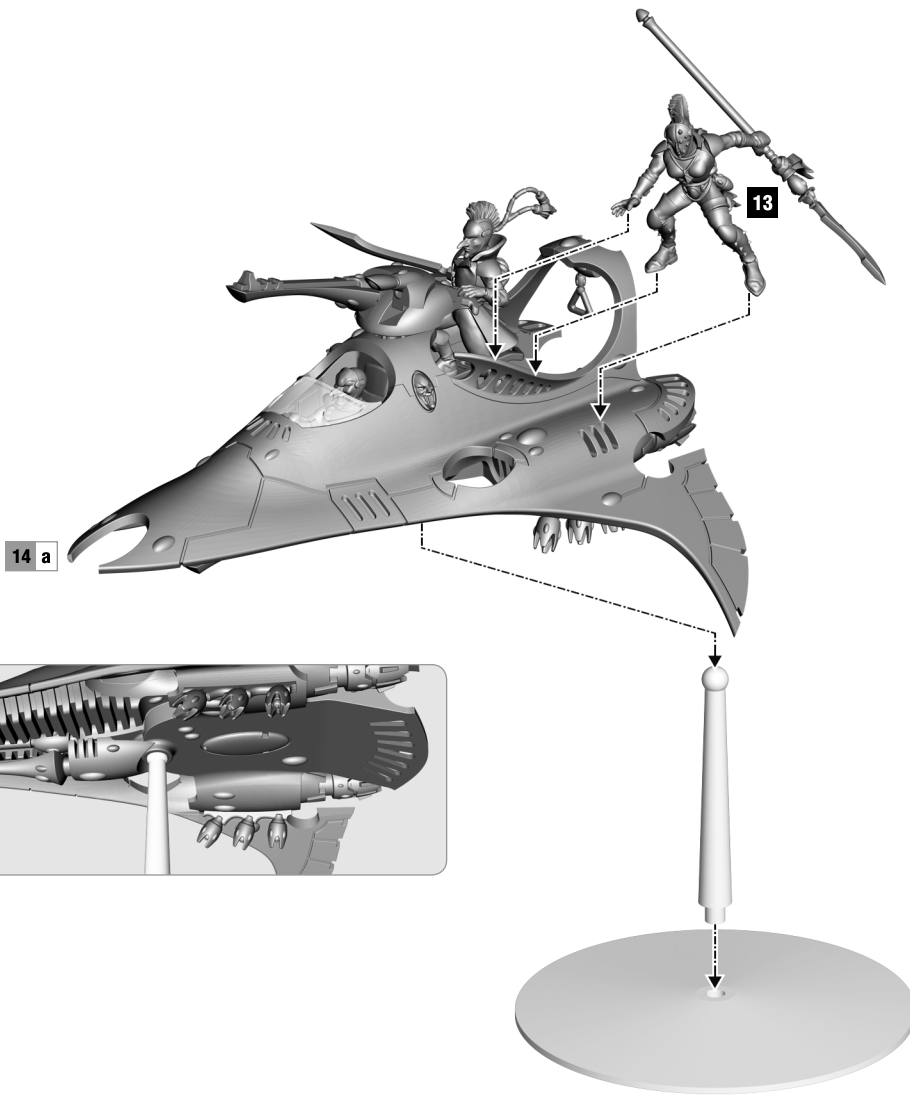

15 a

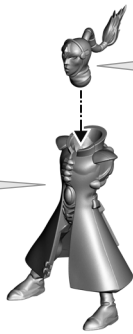
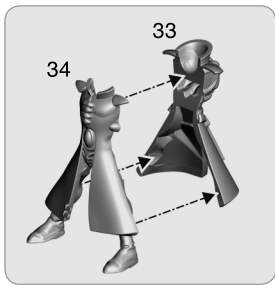

68 55

54 x3

56 57

58 59 60 61 62

63 64 65 66 67

15 b

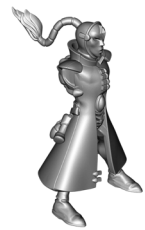
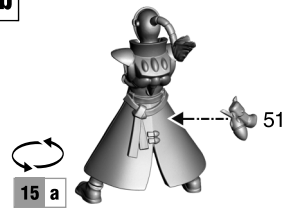

16 a

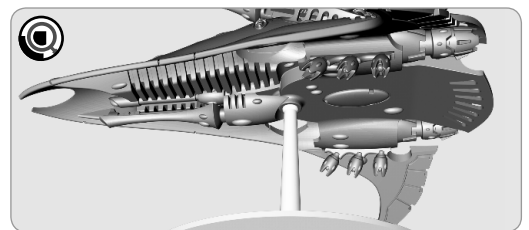
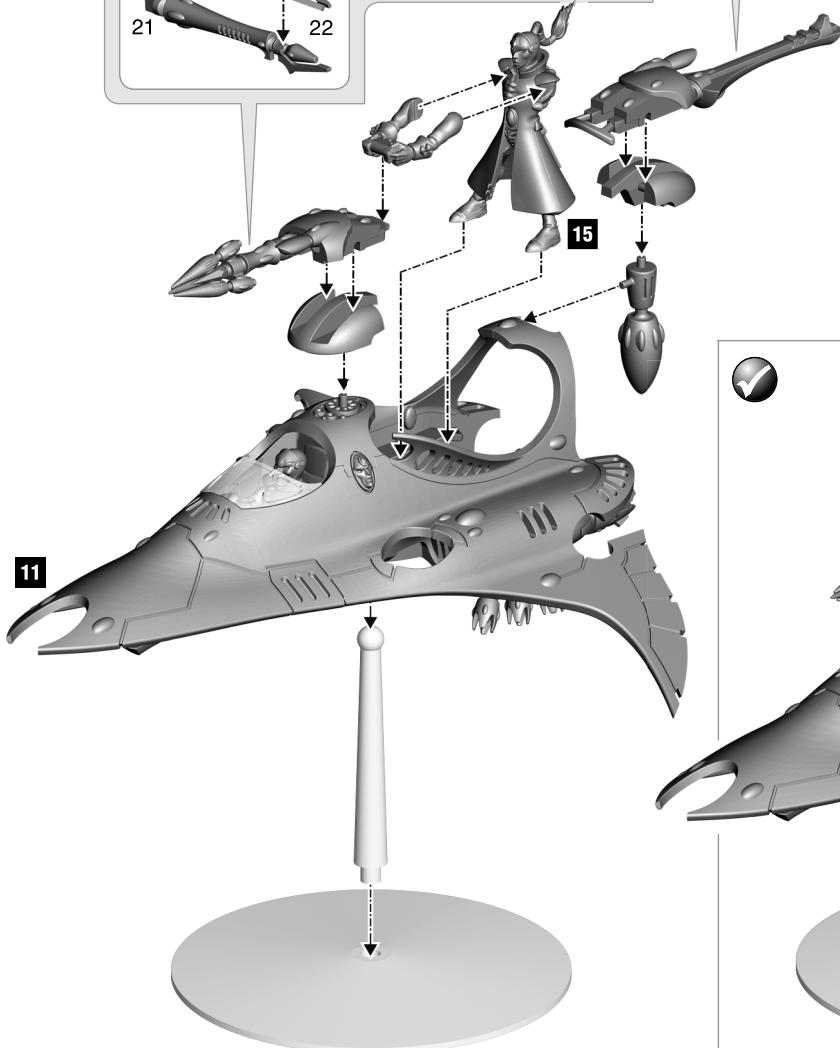
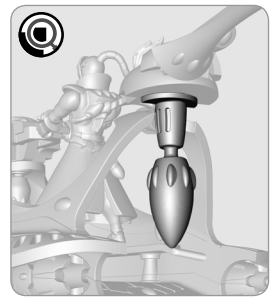
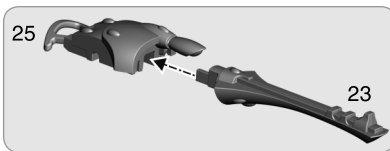
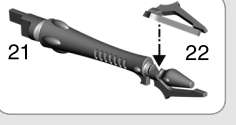
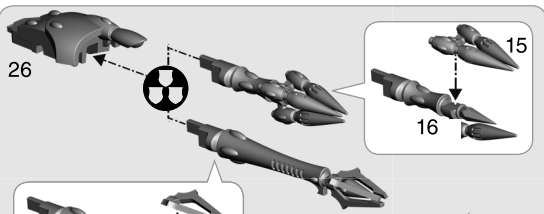

SKYWEAVERS

1

A

x2

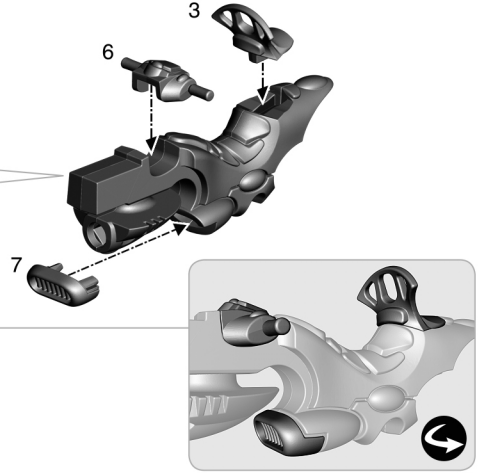
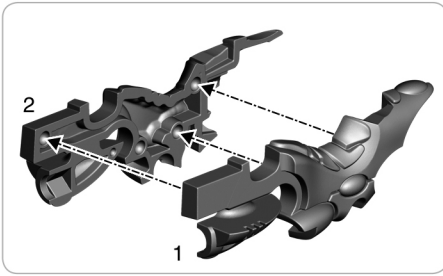

B

x2

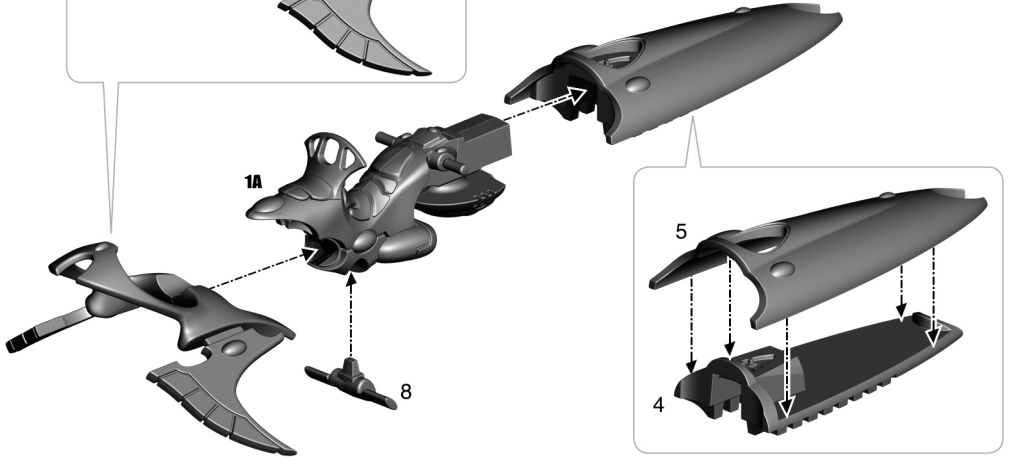
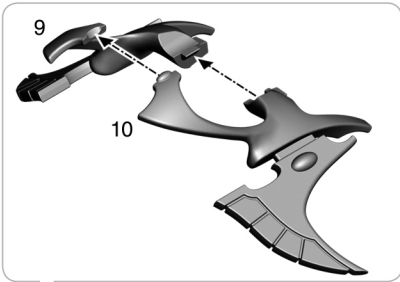

C

x2

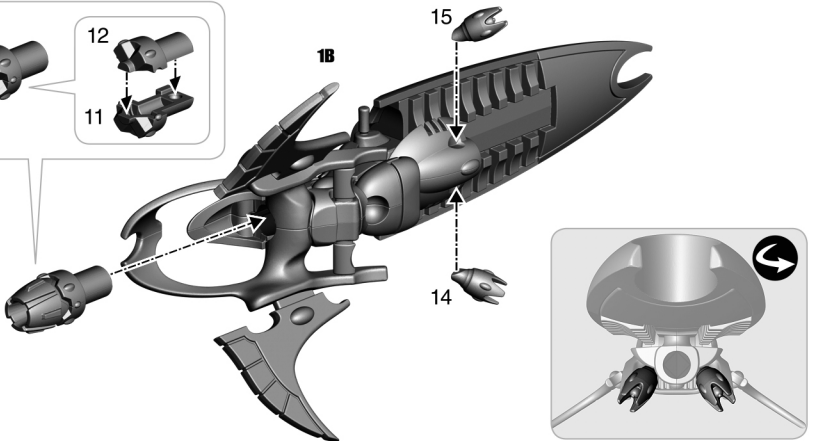
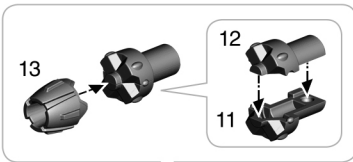

D

x2

16



1c

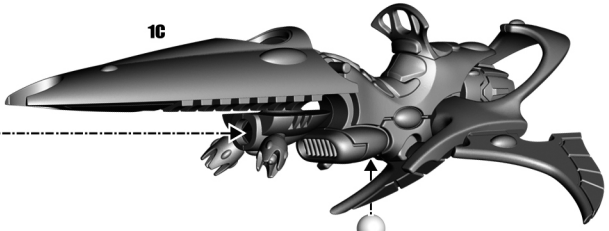

17



18

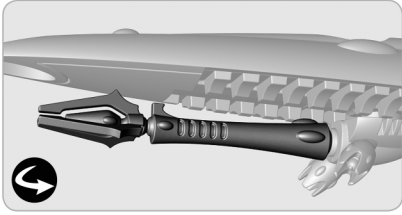

✓

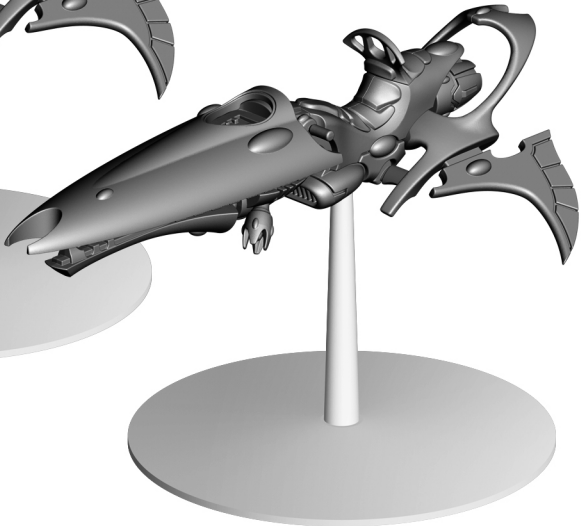
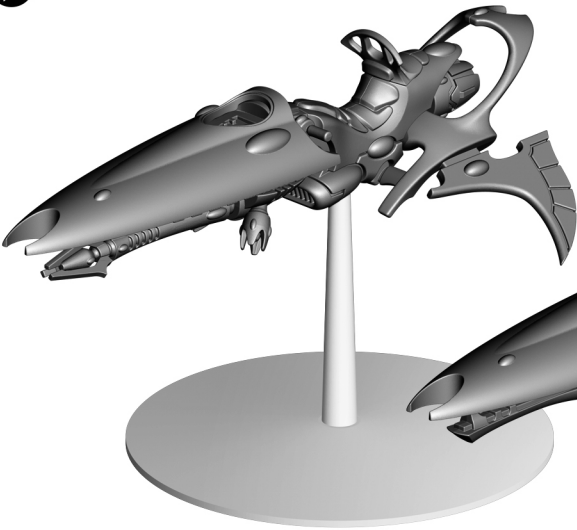
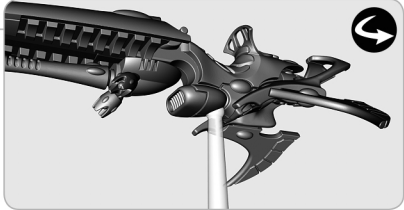

2 MALE RIDER • GUERRIER • TRIPULANTE HOMBRE • MÄNNLICHER PASSAGIER • EQUIPAGGIO MASCHIO

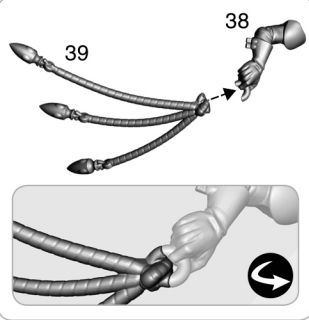
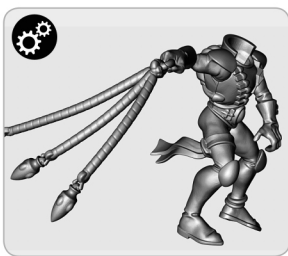
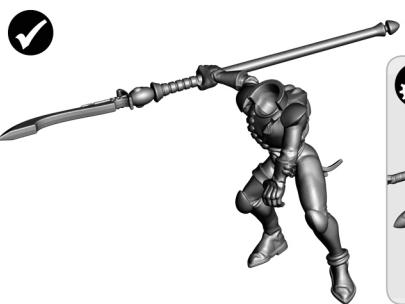
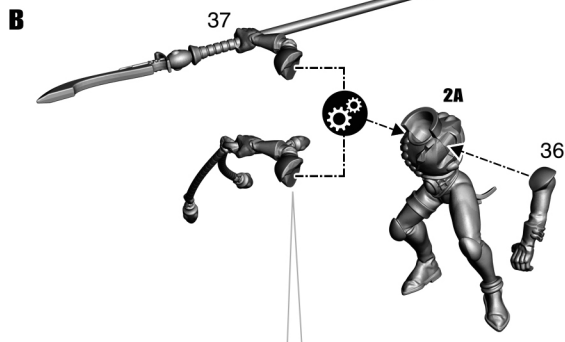
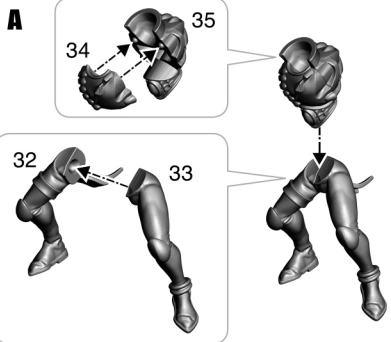

3 FEMALE RIDER • GUERRIÈRE • TRIPULANTE MUJER • WEIBLICHER PASSAGIER • EQUIPAGGIO FEMMINA

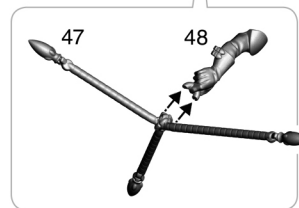
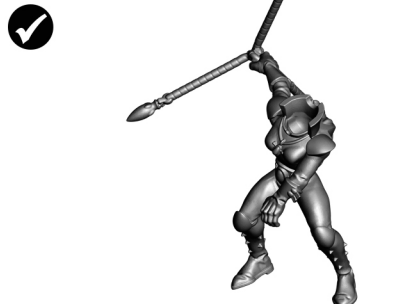
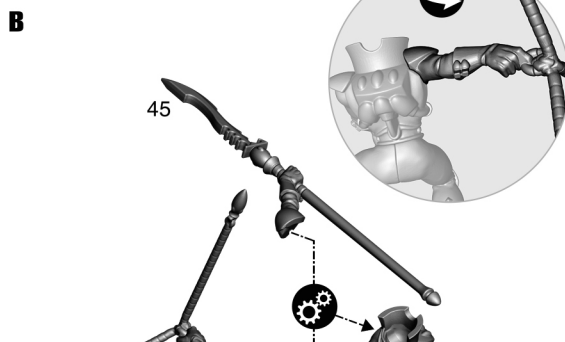
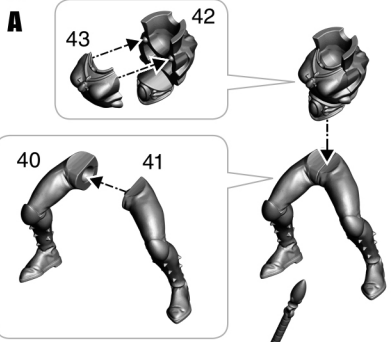

4 MALE PILOT • PILOTE MASCULIN • PILOTO HOMBRE • MÄNNLICHER PILOT • PILOTA MASCHIO

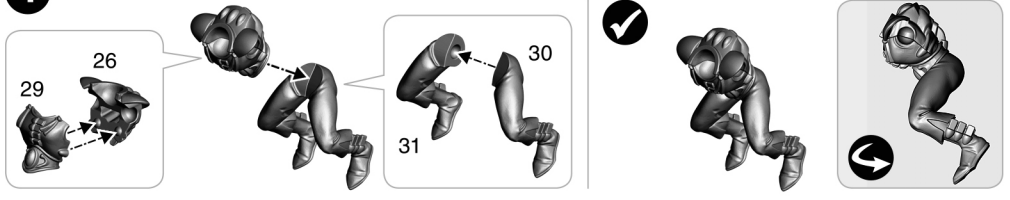

5 FEMALE PILOT • PILOTE FÉMININ • PILOTO MUJER • WEIBLICHE PILOTIN • PILOTA FEMMINA

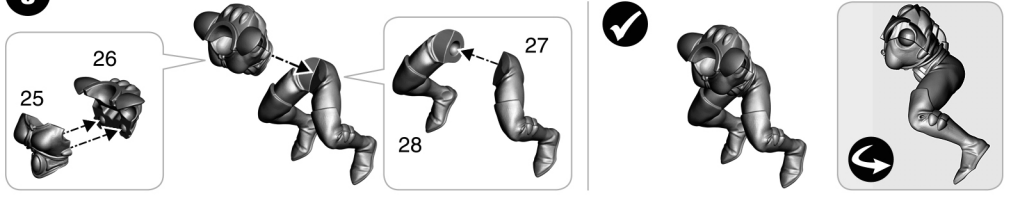

6 FINAL ASSEMBLY • ASSEMBLAGE FINAL • MONTAJE FINAL • ABSCHLIEßENDER ZUSAMMENBAU • ASSEMBLAGGIO COMPLETO

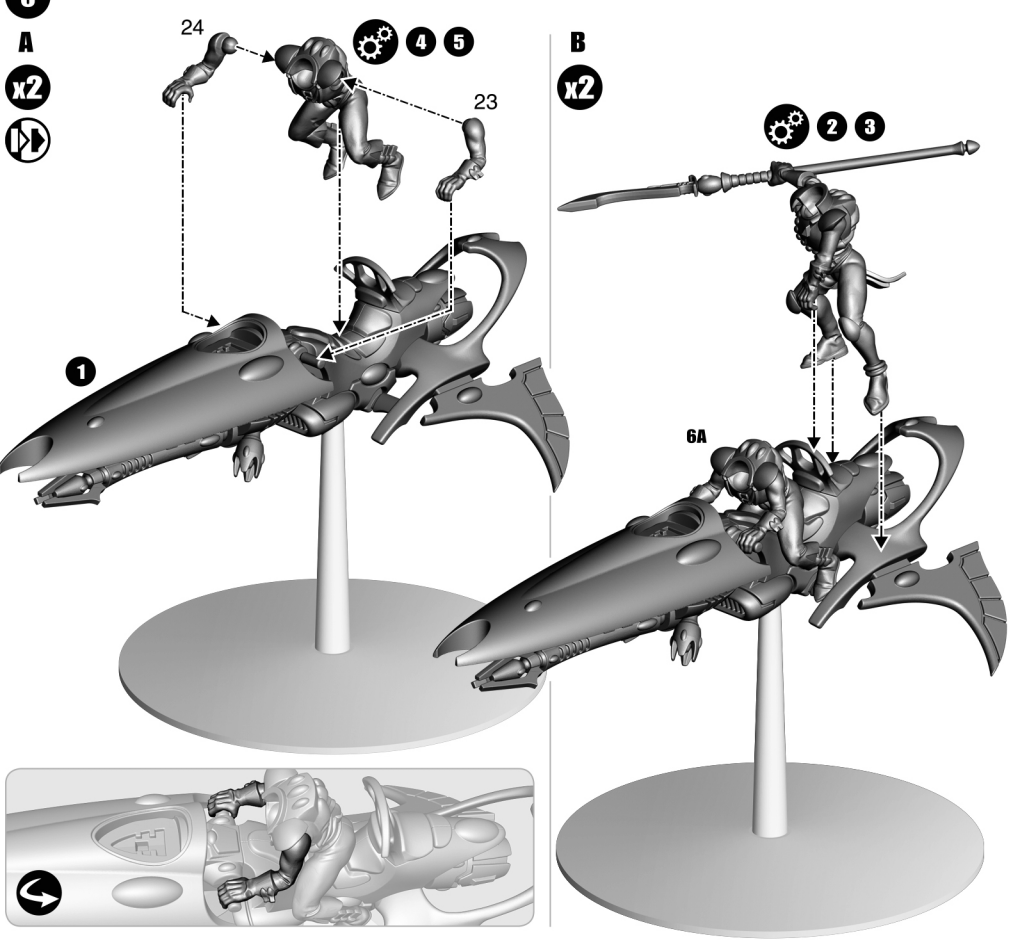

G

x2



x4



57



48

x4



49



50



51



52



53



54



55



56



x2



19



20



21



22



58 x4

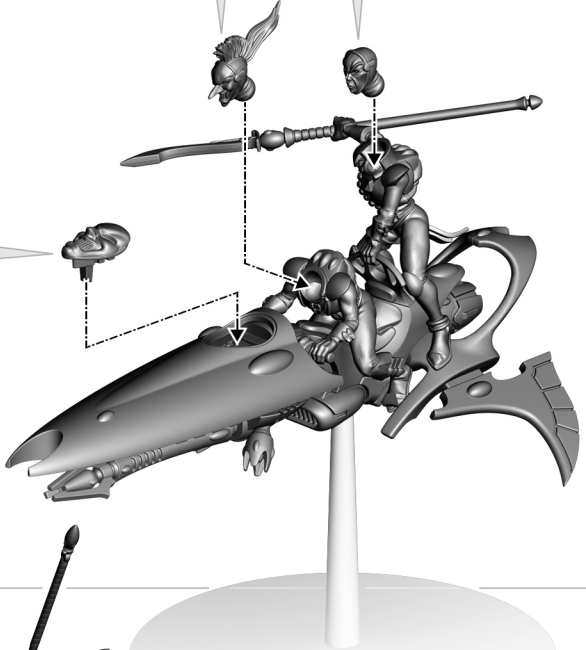
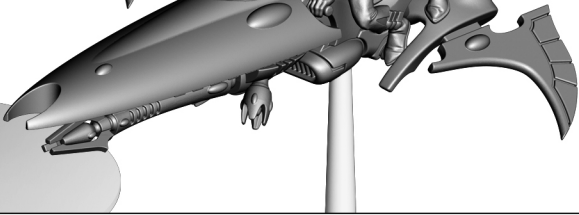
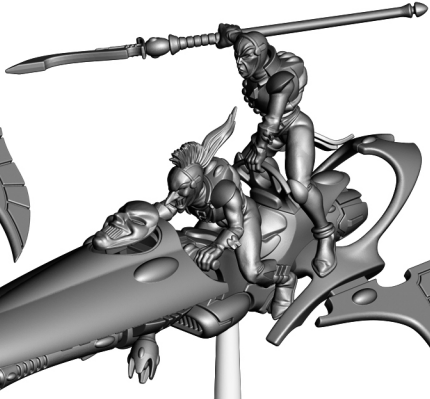
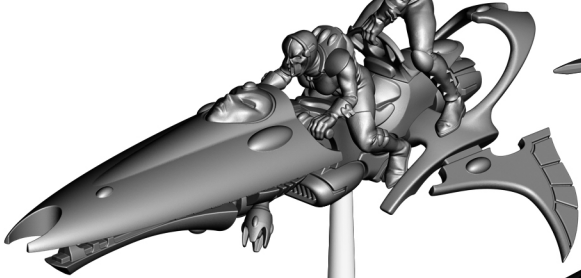
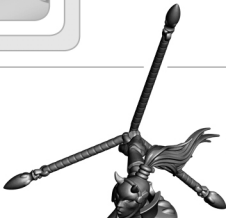

17 WATCH CAPTAIN ARTEMIS

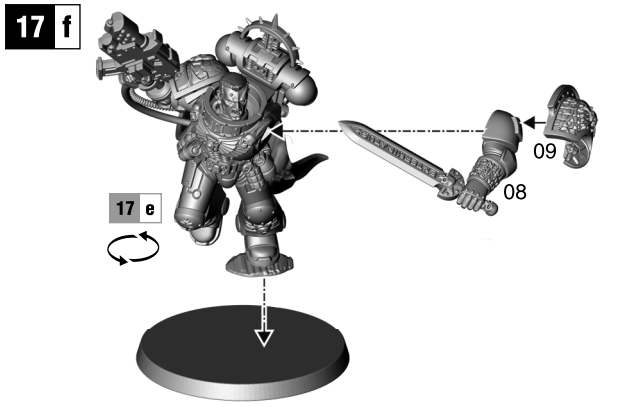
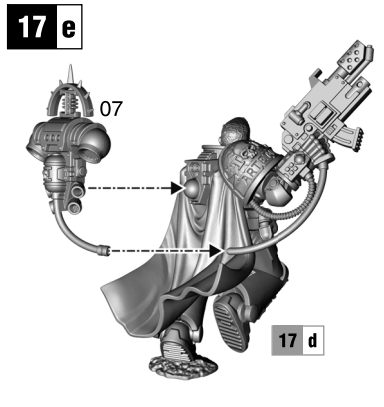
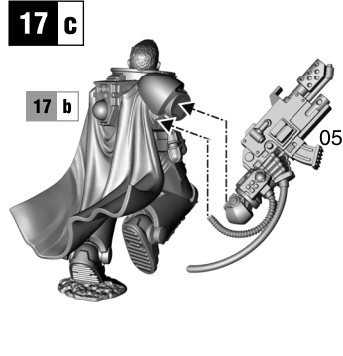
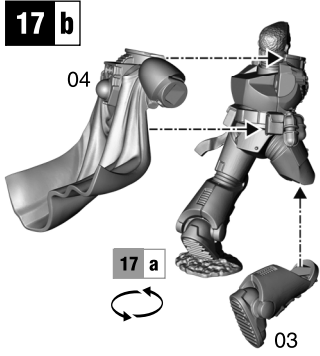
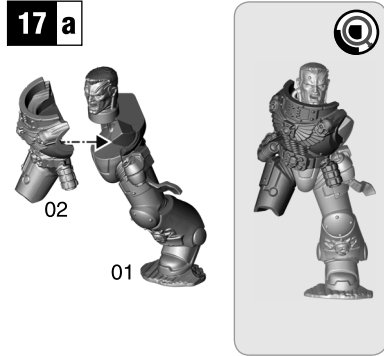

18 - 26 VENERABLE DREADNOUGHT

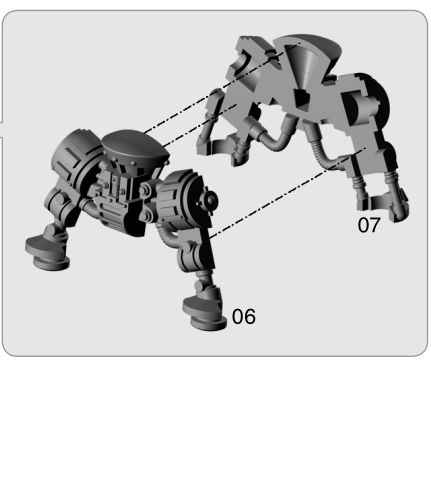
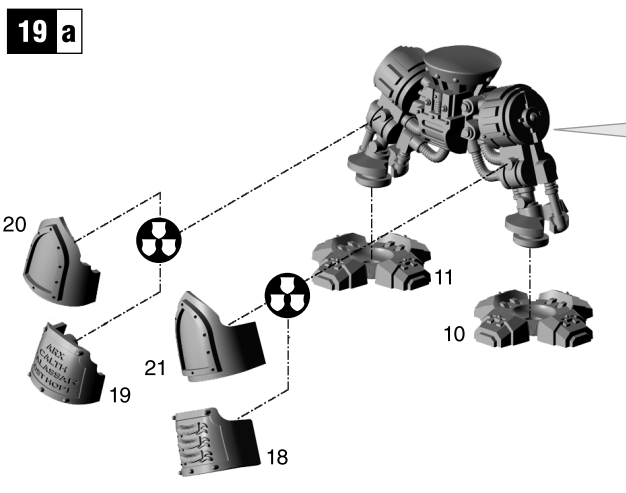
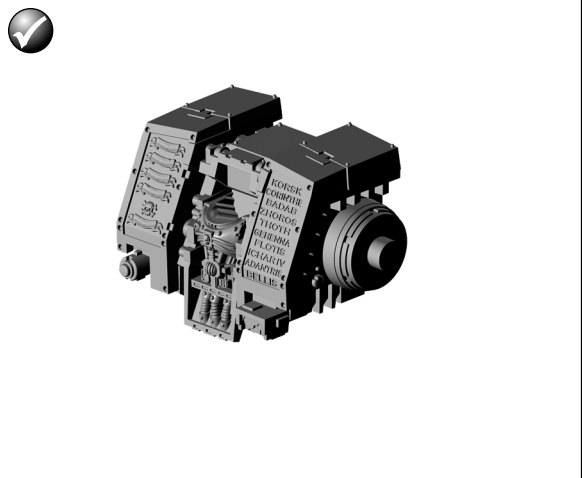
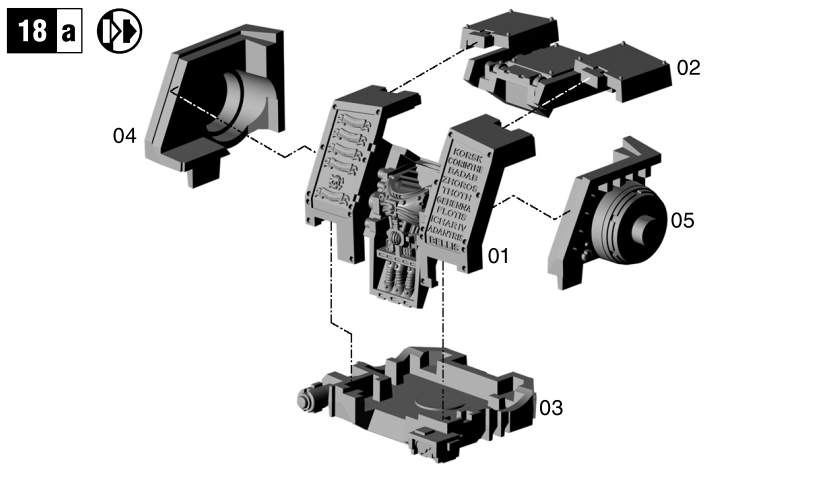

20 a

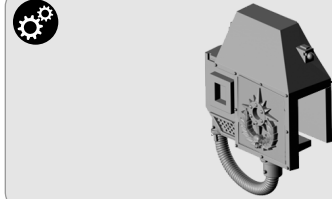
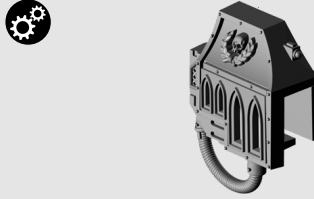
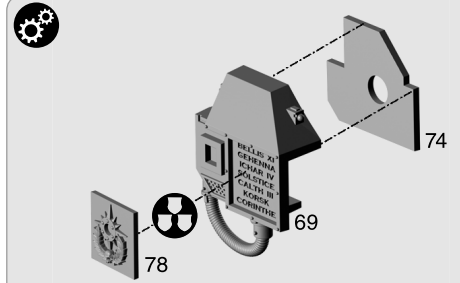
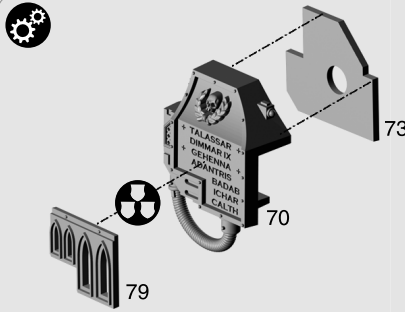
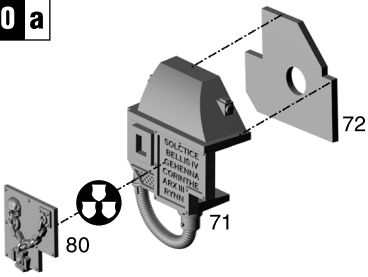

21 a

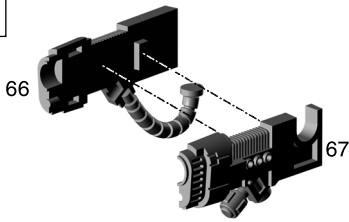

21 b

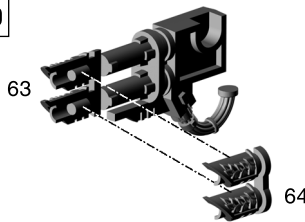

21 c

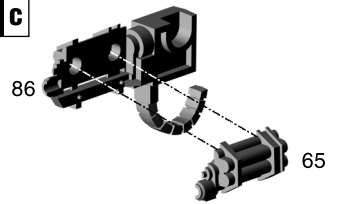

Plasma cannon

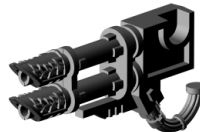

Twin-linked lascannon

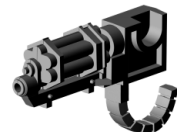

Assault cannon

22 a

x3

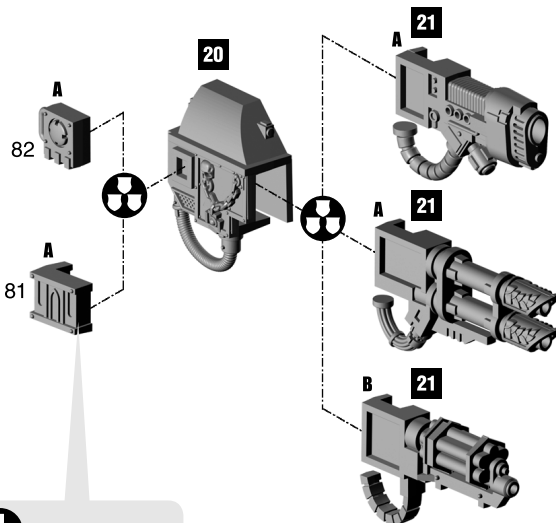

Match the ammo boxes to the correct weapon
 Le chargeur de munitions doit correspondre à l'arme
 Encaja las cajas de munición en el arma correcta
 Wähle die Munitionsboxen passend zur Waffe
 Abbina le scatole di munizioni all'arma giusta

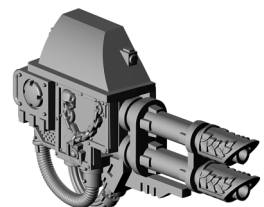
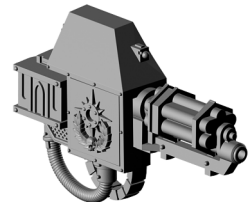

23 a

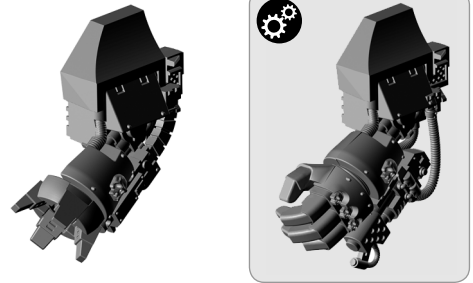
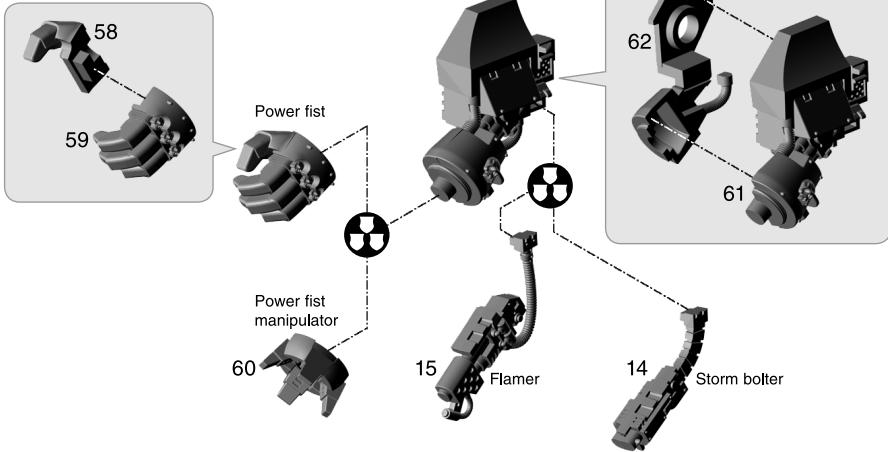

24 a

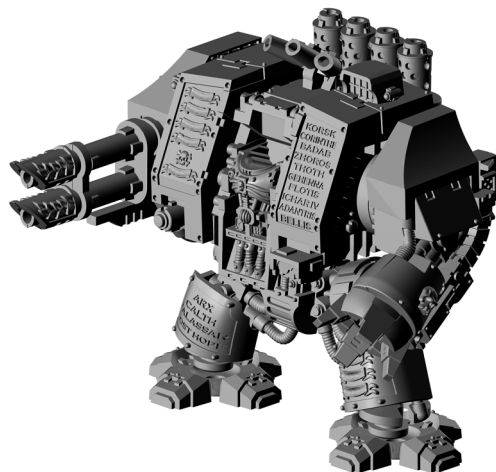
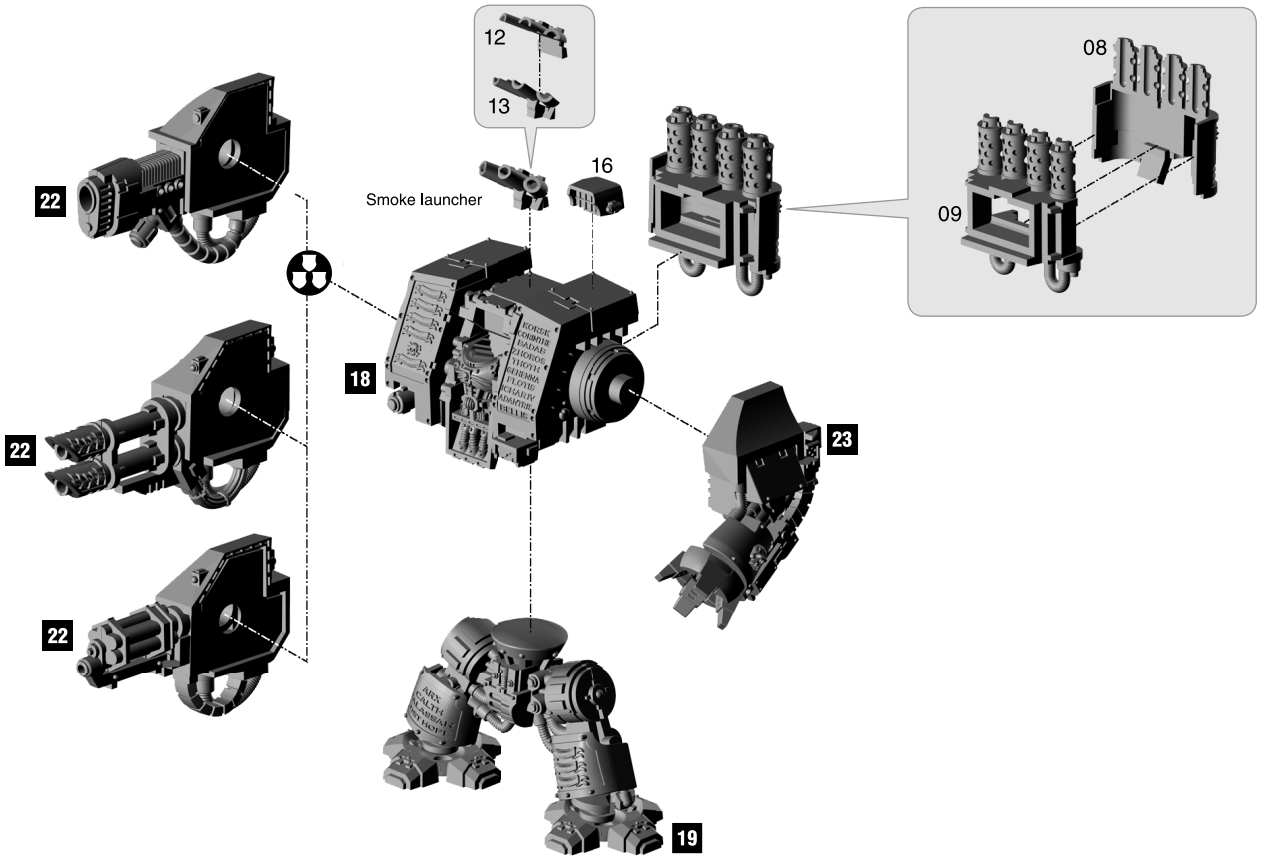

25 a

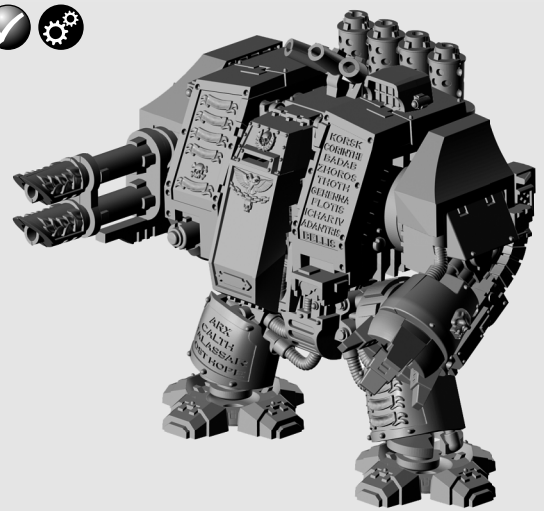
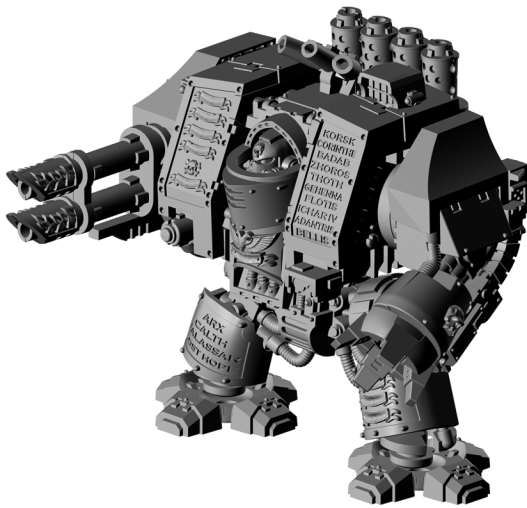
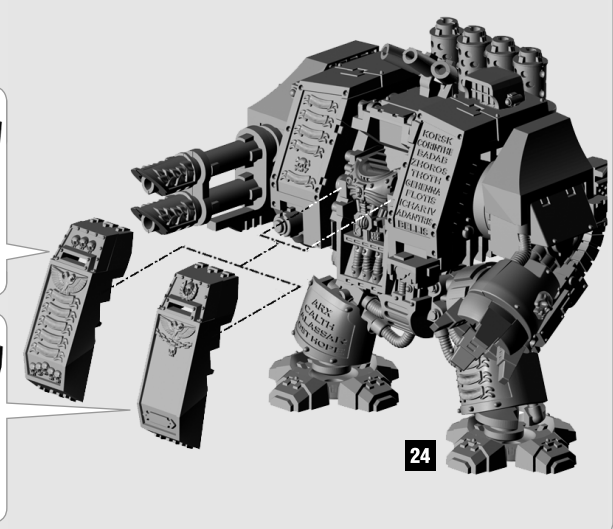
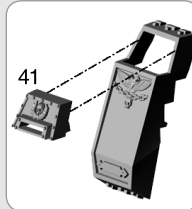
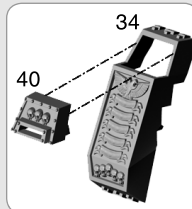
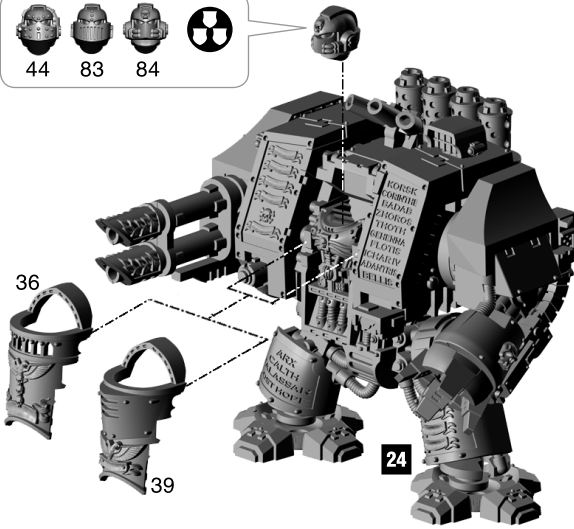
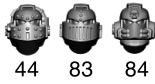

26 a

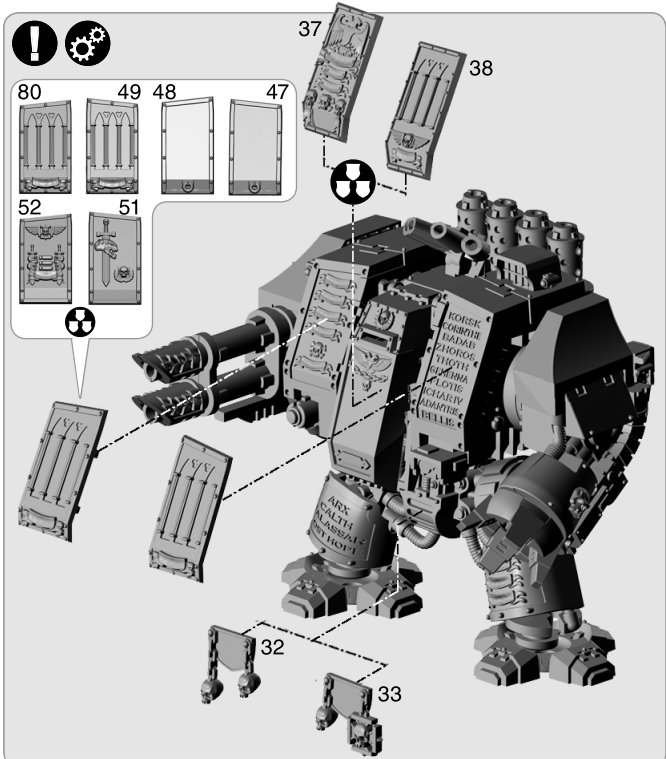
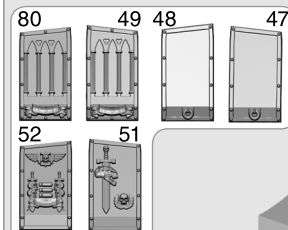
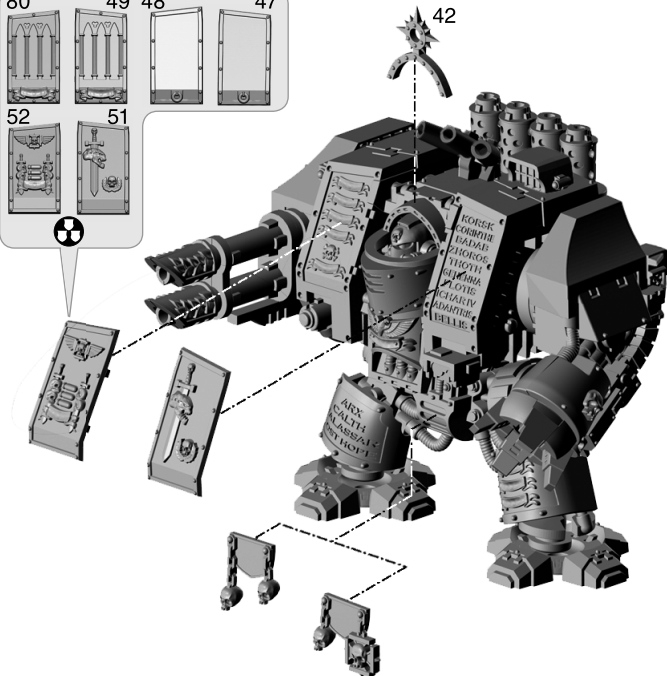
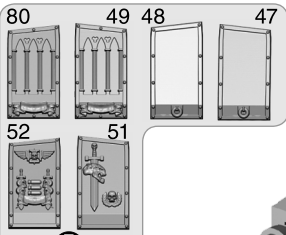



The purity seals and scrolls are optional extras and may be placed anywhere upon the Dreadnought.

Les sceaux de pureté et les parchemins sont des options et peuvent être placés n'importe où sur le Dreadnought.

Los sellos de pureza y los pergaminos son extras opcionales que puedes colocar en cualquier punto del dreadnought.

Die Reinheitsiegel und Schriftrollen sind optional und können nach Belieben am Cybot befestigt werden.

Sigilli di purezza e pergamene sono accessori extra che si possono collocare ovunque sul dreadnought.

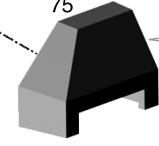
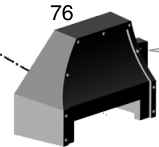
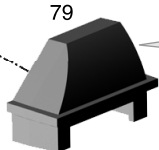
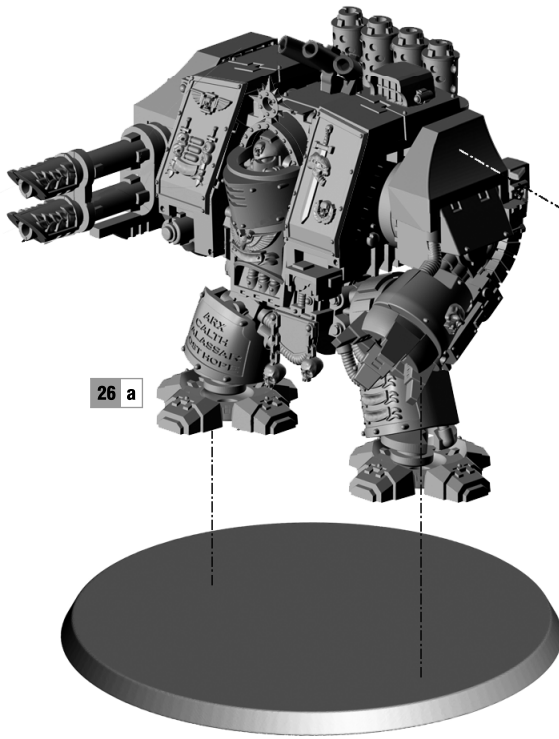
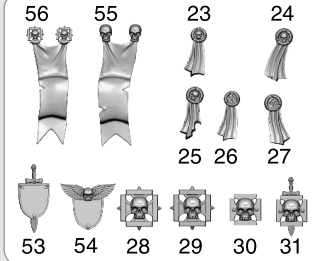

Match left shoulders to right shoulders (see stage 20)
L'épaulière gauche doit correspondre à l'épaulière droite (voir étape 20)

Encaja hombros izquierdos y derechos (consulta el paso 20)

Pass die linke Schulter an die rechte Schulter an (siehe Schritt 20)

Abbina la spalla destra a quella sinistra (vedi fase 20)

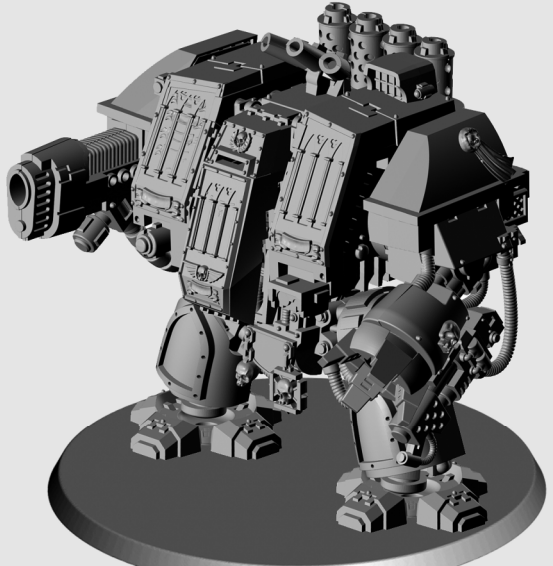
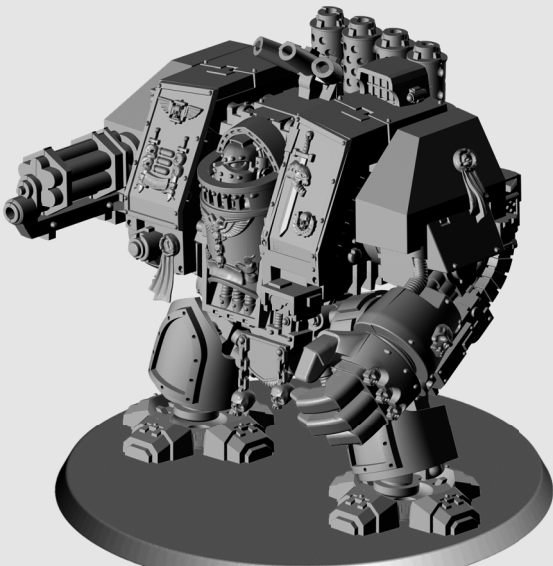
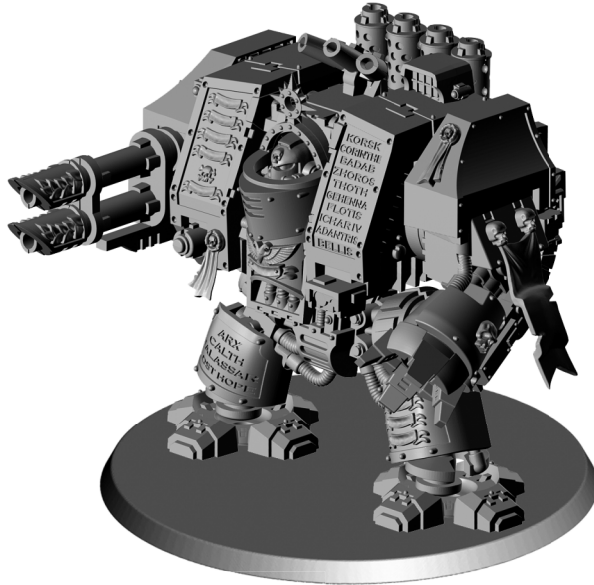

27 a

INTERCHANGEABLE PARTS • ÉLÉMENTS INTERCHANGEABLES • PARTES INTERCAMBIABLES
• AUSTAUSCHBARE TEILE • COMPONENTI INTERCAMBIABILI

x5

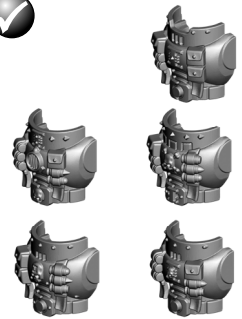
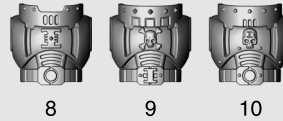
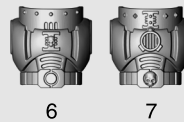
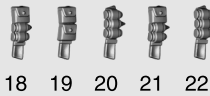
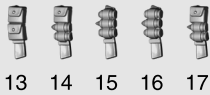

27 b

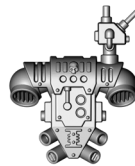
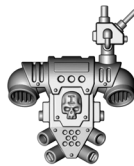
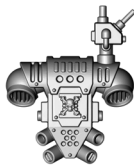
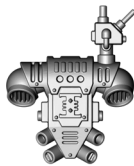
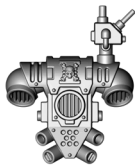

27 c



27 d



28 a

WATCH SERGEANT

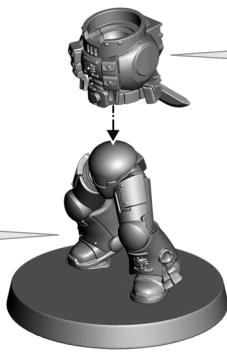
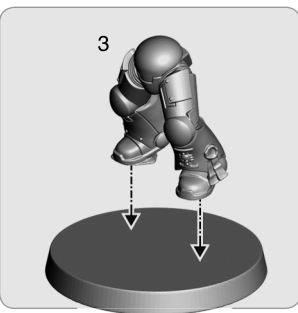

27 a

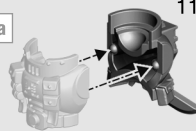

Power sword

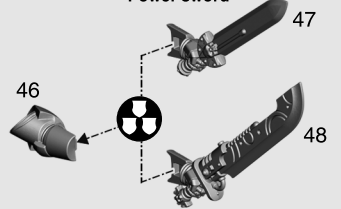

Xenophase blade

28 b

Combi-plasma Combi-melta

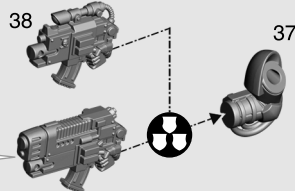
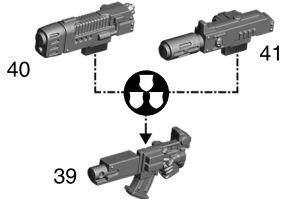

28 a

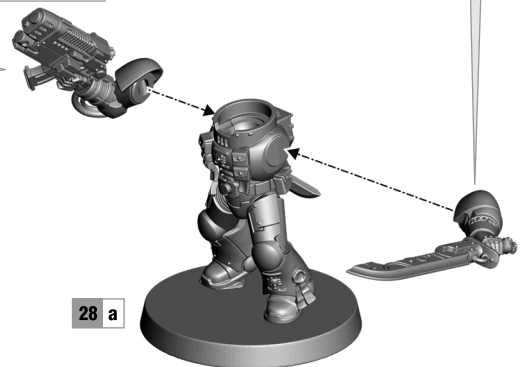

28 c

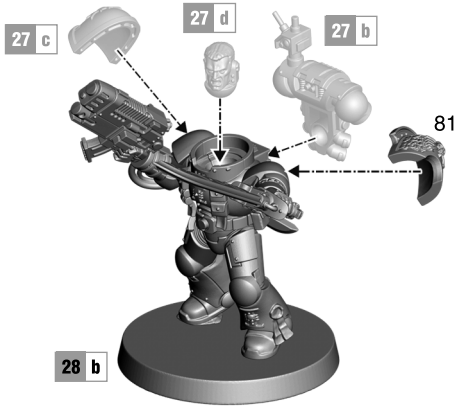

29 a

VETERAN WITH HEAVY WEAPON

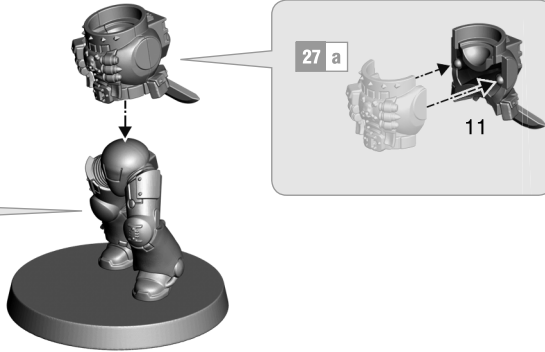
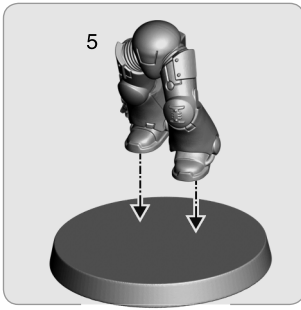

29 b

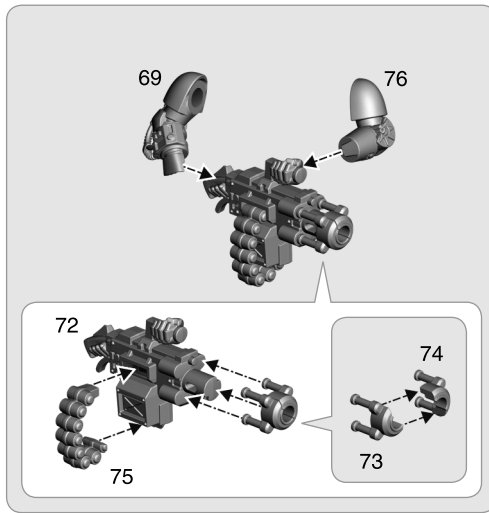
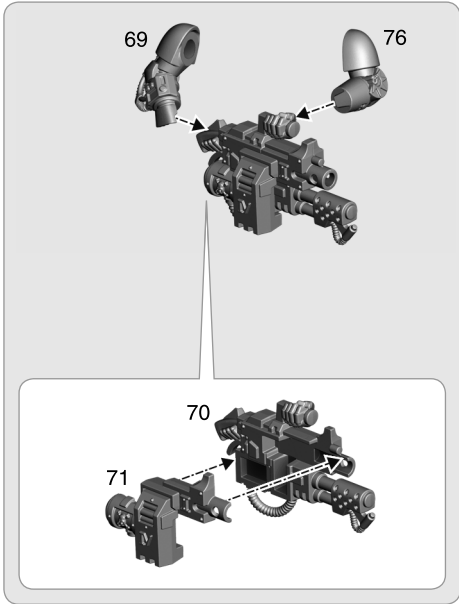
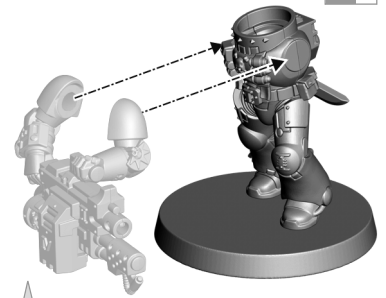

Infernus heavy bolter

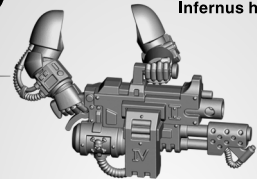

Deathwatch frag cannon

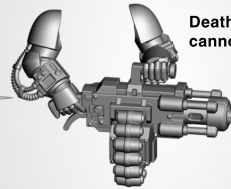

29 c

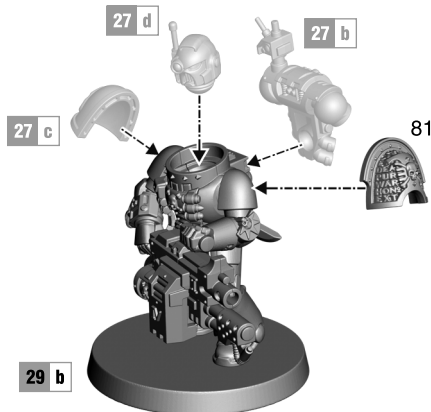

30 a VETERAN WITH STORMSHIELD AND POWER MAUL

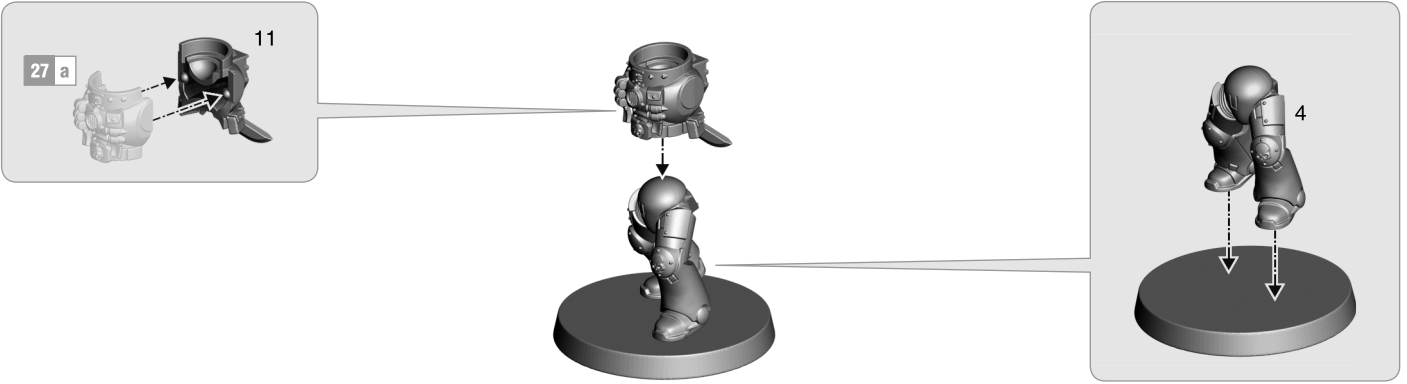

30 b

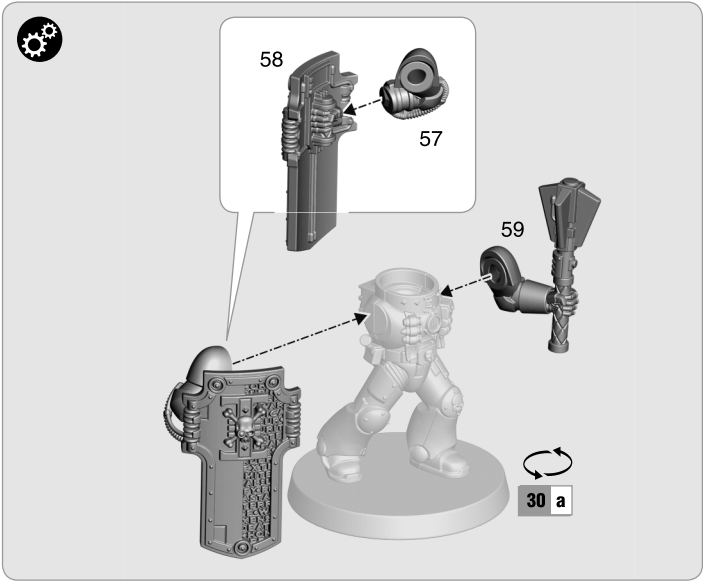
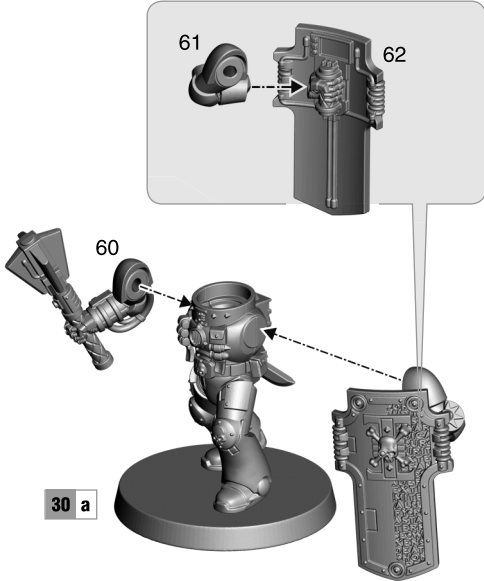

30 c

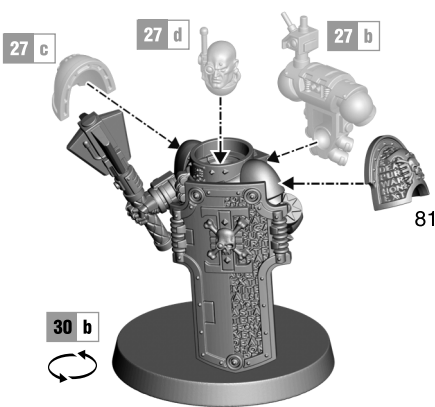

31 a VETERAN WITH HEAVY THUNDER HAMMER



31 b

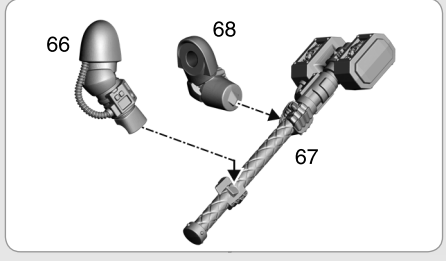
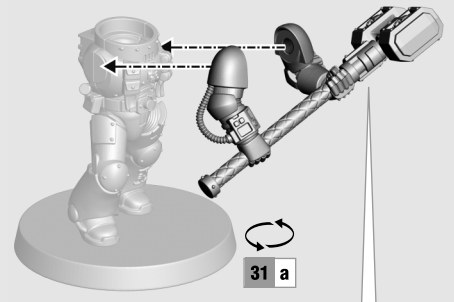
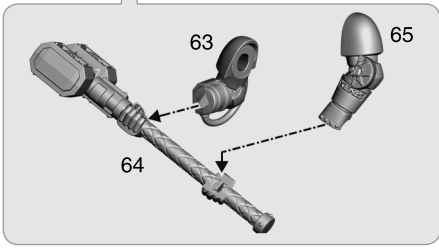
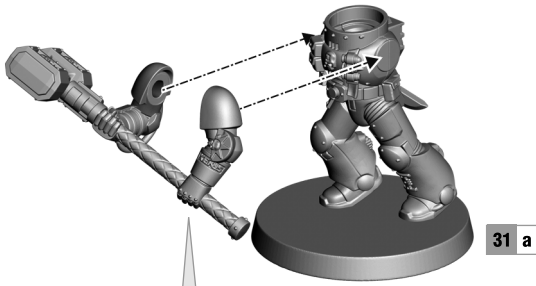

31 c

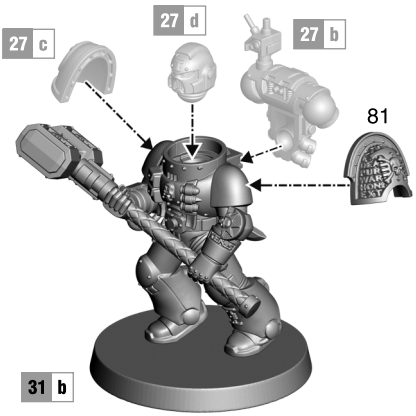

32 a; b; e



with boltgun & power sword

32 a; c; e

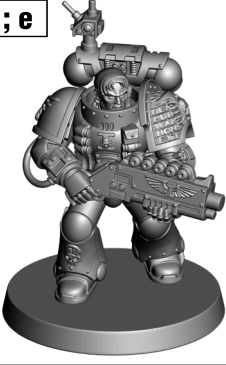

with Deathwatch shotgun

32 a; d; e



with stalker pattern boltgun

32 a

VETERAN WITH RANGED WEAPON

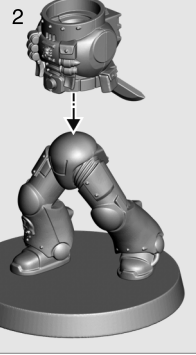
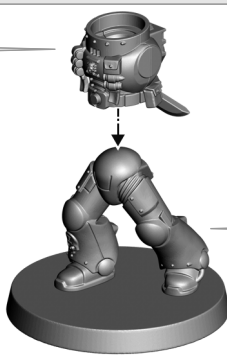
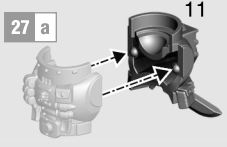

32 b

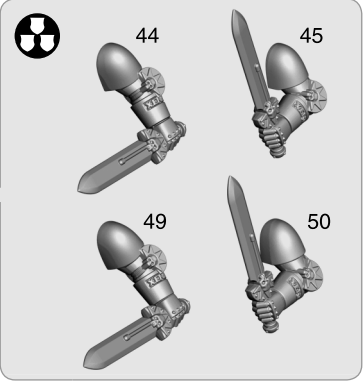
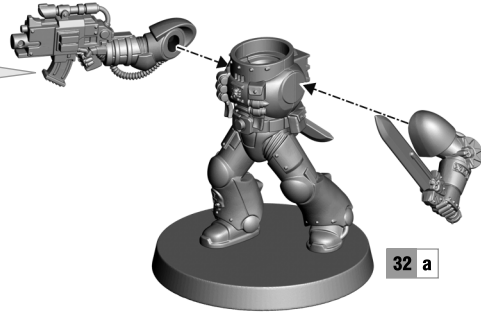
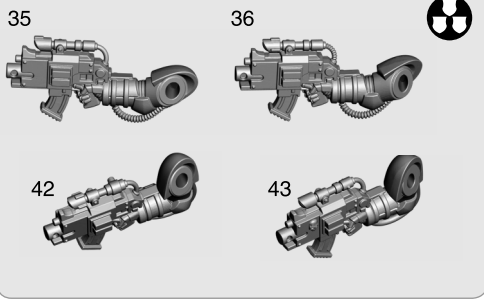

32 c

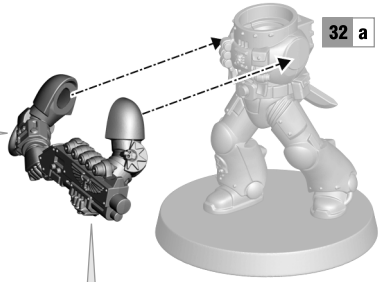
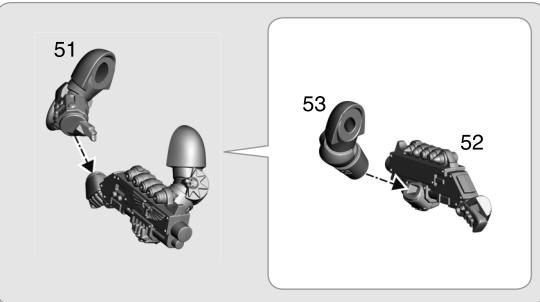

32 d

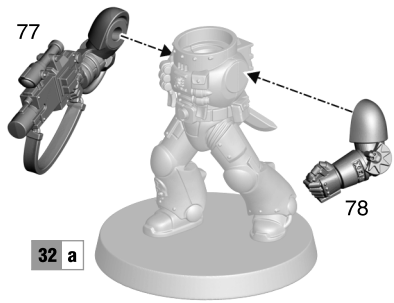

32 a

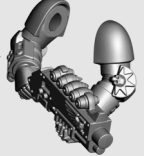
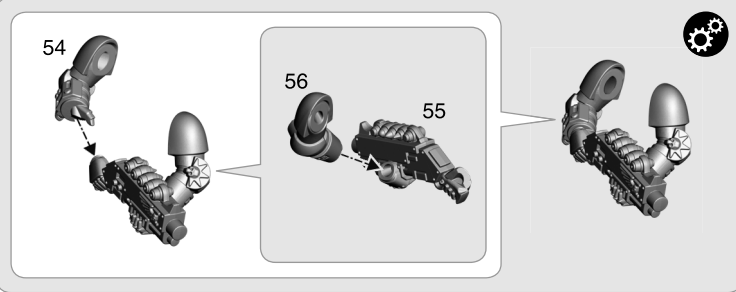

32 e

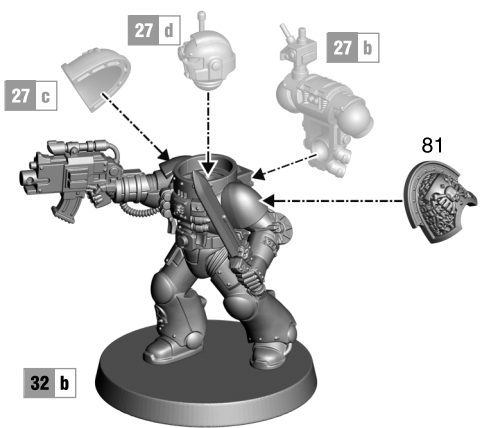

32 b



with boltgun & power sword

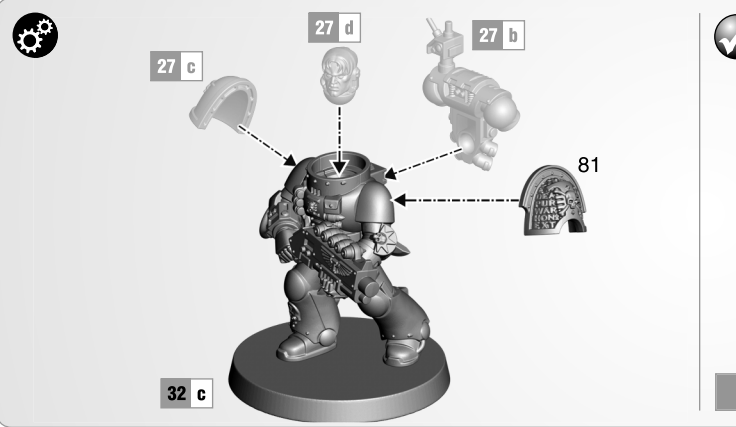

32 c



with Deathwatch shotgun

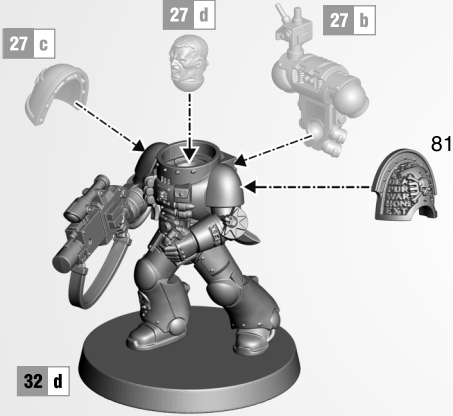

with stalker pattern boltgun

33 a



BLACK SHIELD

• OPTIONAL VARIANT ASSEMBLY • ASSEMBLAGE OPTIONNEL • OPCIÓN DE MONTAJE ALTERNATIVA
 • OPTIONALE BAUVARIANTE • ASSEMBLAGGIO DELLA VARIANTE OPZIONALE

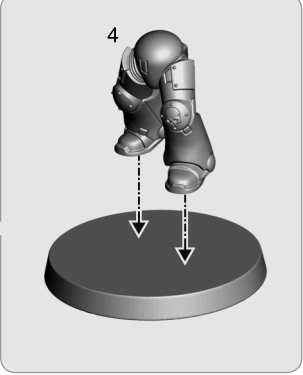
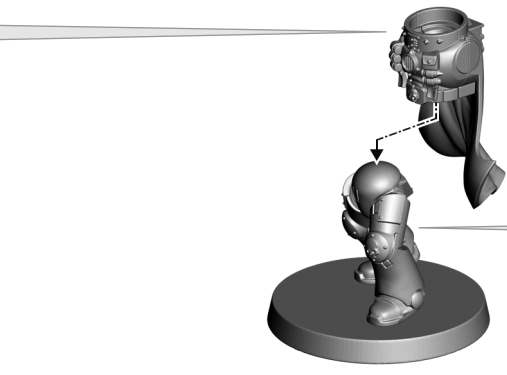
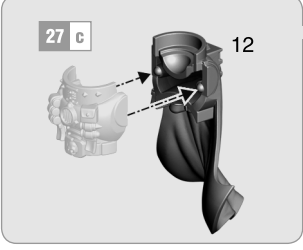

33 b

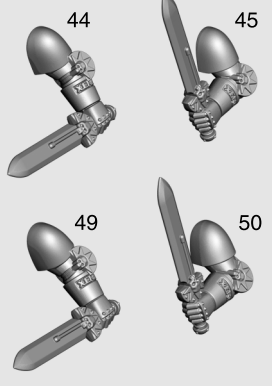
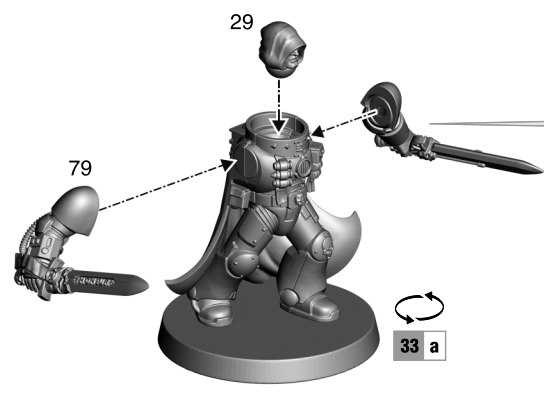

33 c

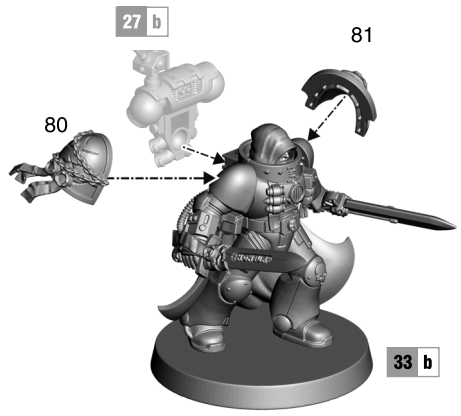

34 a INTERCHANGEABLE PARTS • ÉLÉMENTS INTERCHANGEABLES • PARTES INTERCAMBIABLES • AUSTAUSCHBARE TEILE • COMPONENTI INTERCAMBIABILI

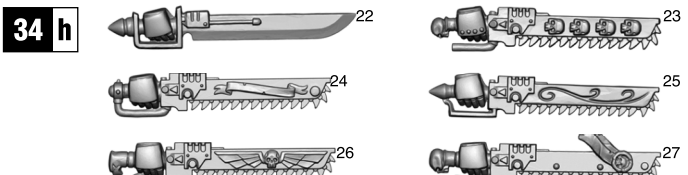
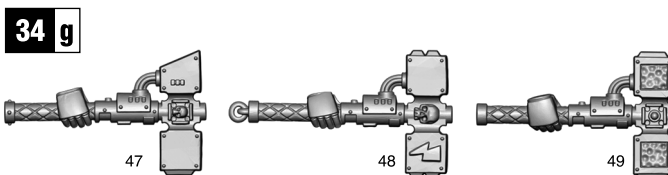
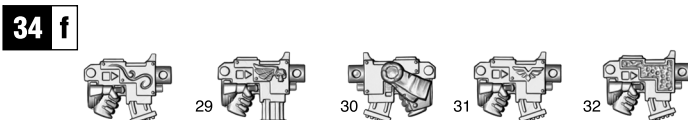
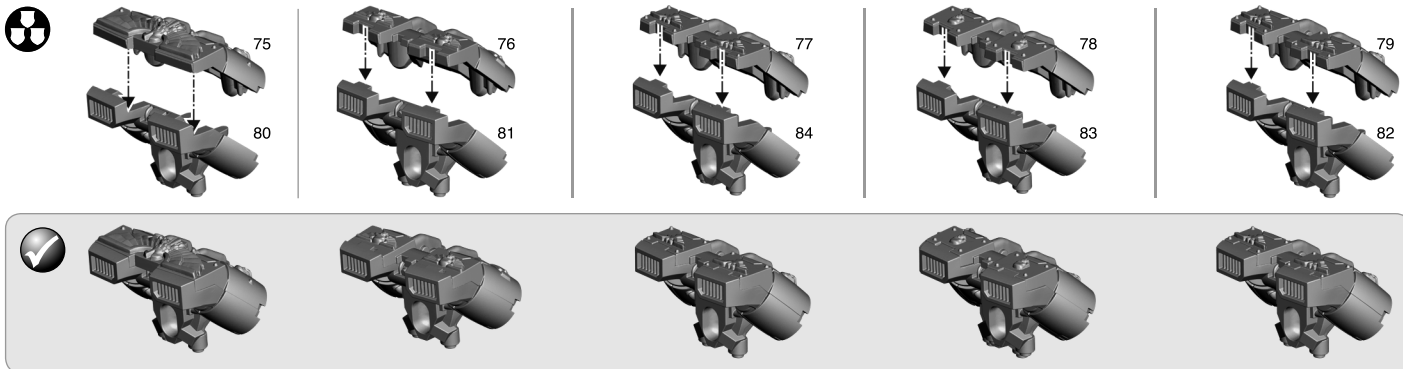

35 a VANGUARD VETERAN WITH RELIC BLADE & GRAV-PISTOL

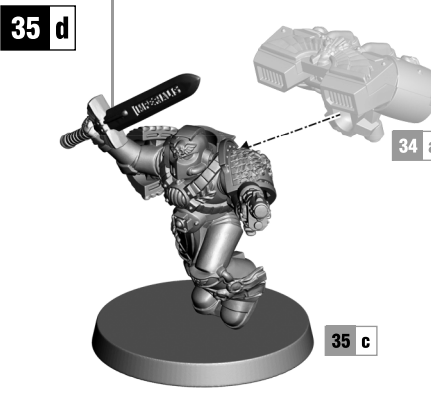
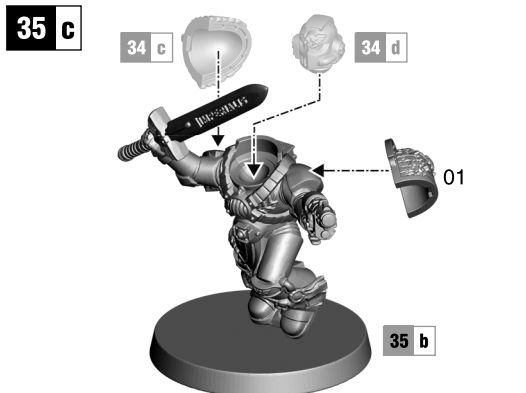
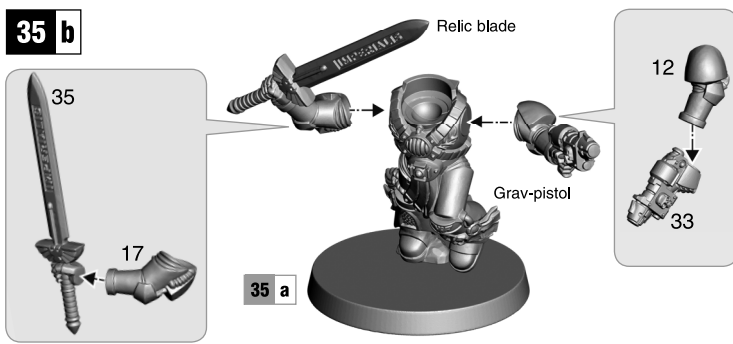
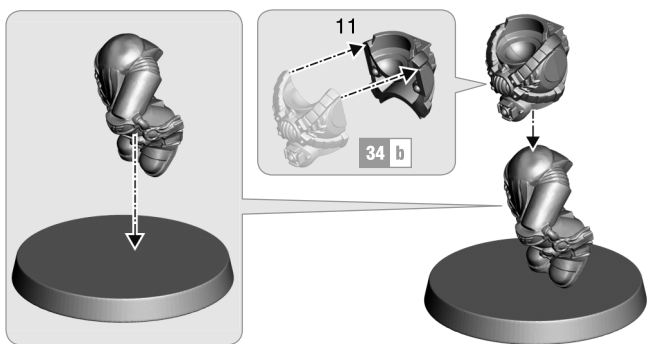

36 a VANGUARD VETERAN WITH THUNDER HAMMER & STORM SHIELD

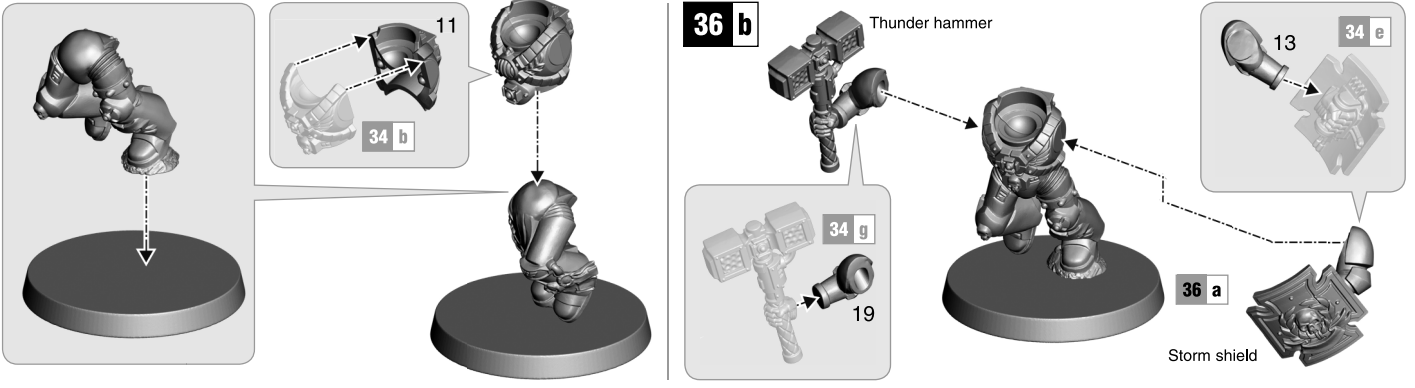

37 a VANGUARD VETERAN WITH LIGHTNING CLAWS

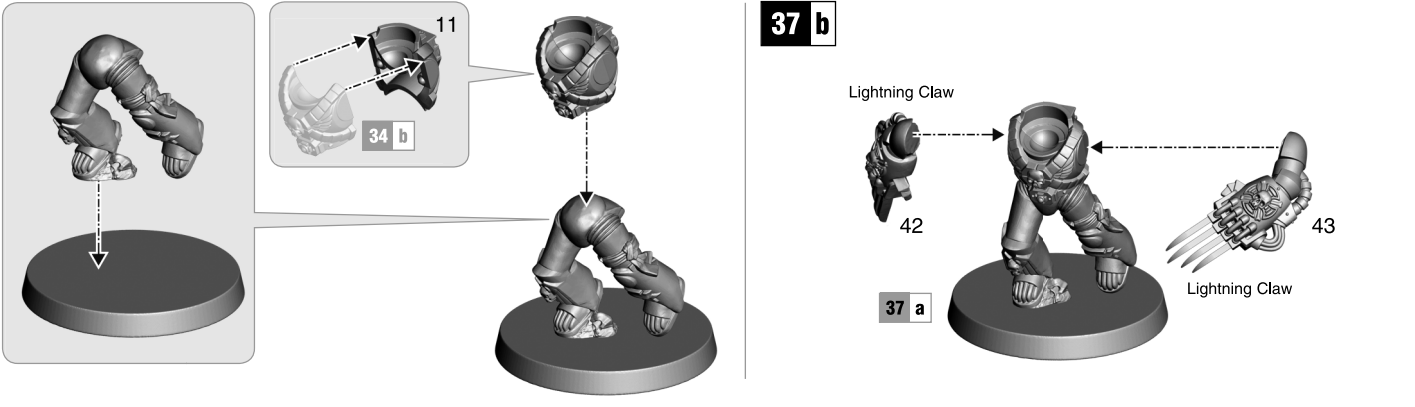

38 a VANGUARD VETERAN WITH CHAINSWORD & BOLT PISTOL

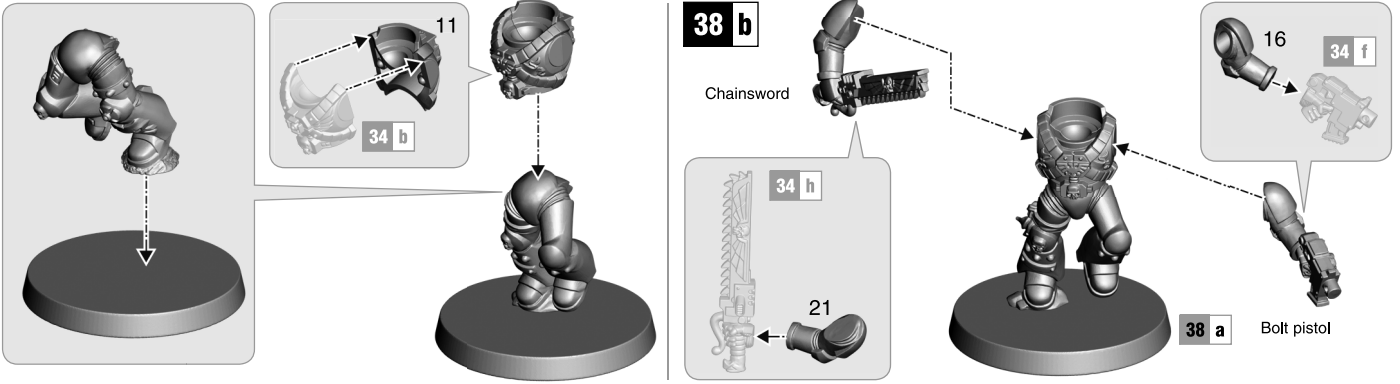

39 a VANGUARD VETERAN WITH POWER FIST & BOLT PISTOL

