

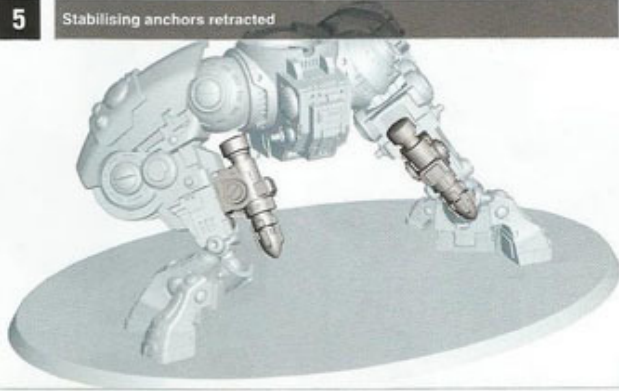

5

Stabilising anchors retracted



6

Stabilising anchors deployed

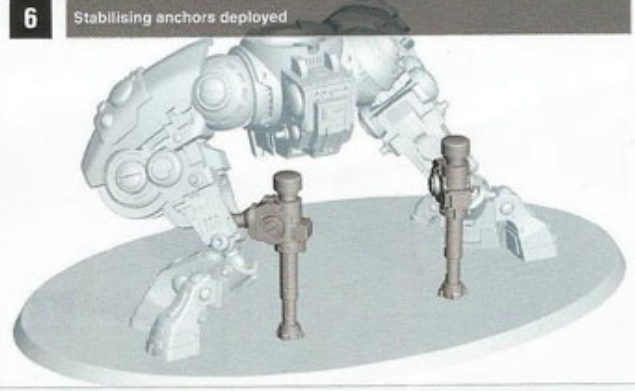

5 a x2



6 a x2



5 b



4

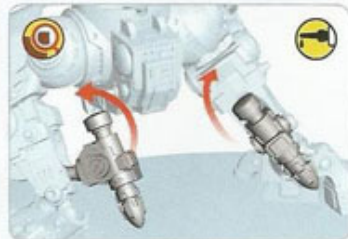
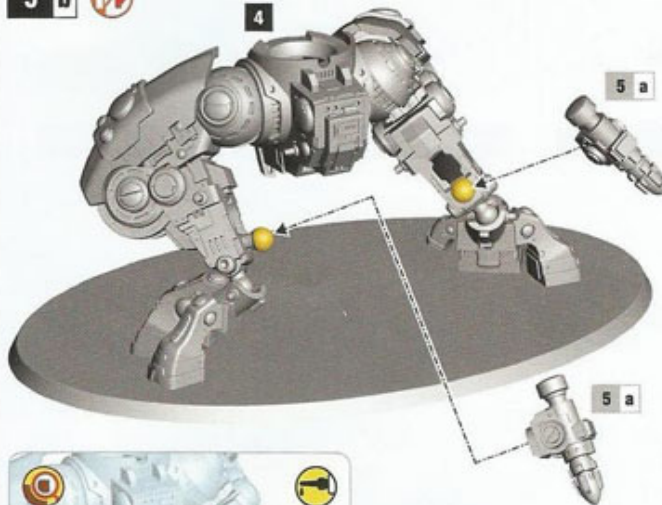

6 b



4

6 a

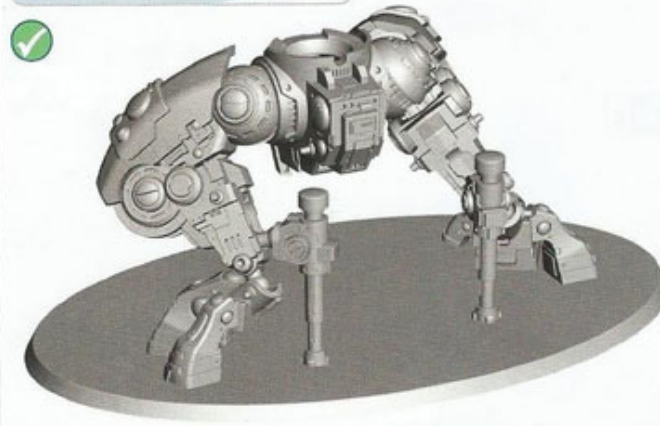
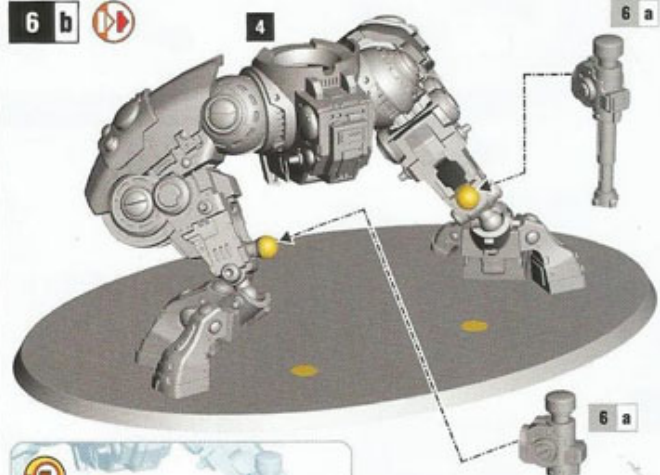

7 a

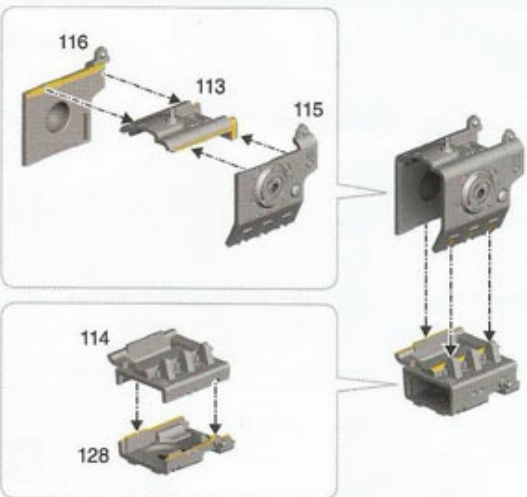

7 b

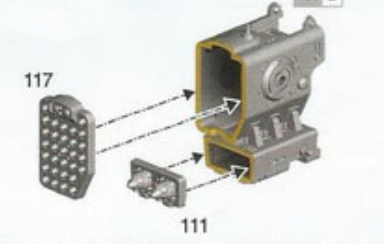

7 d

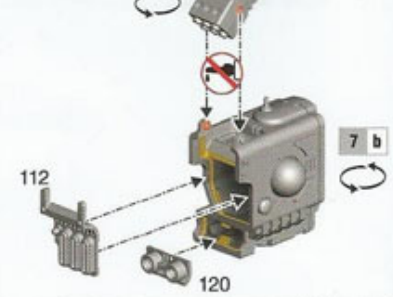

7 c

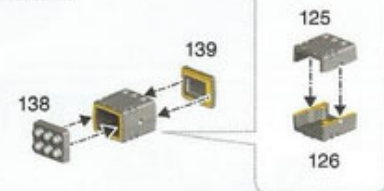

7 e

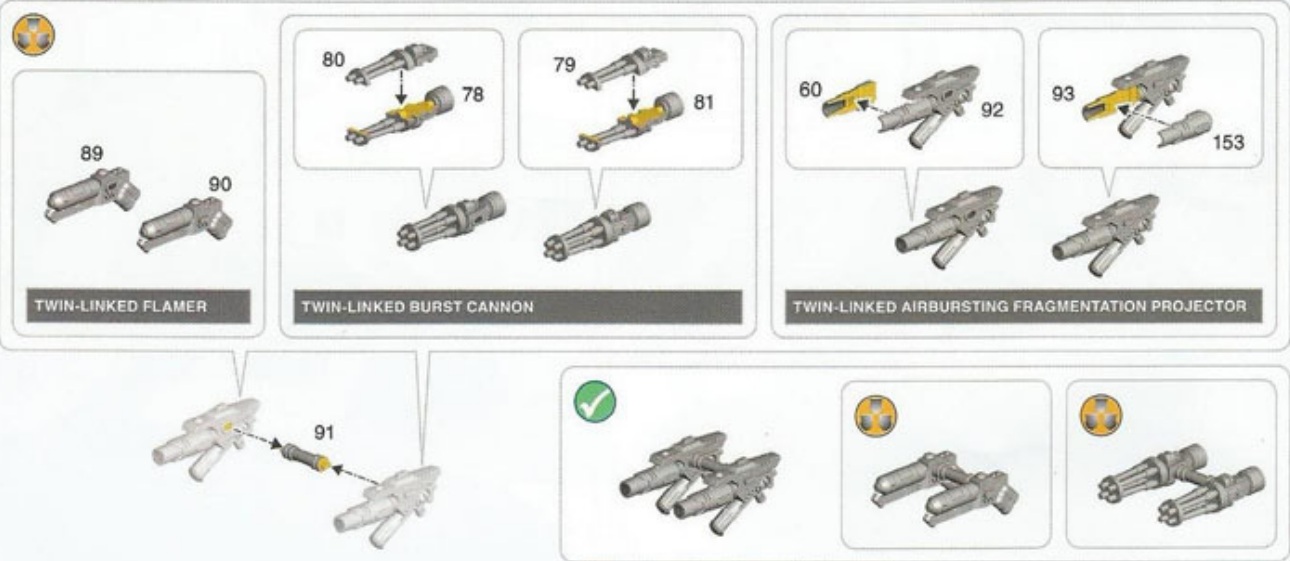

7 f



7 h

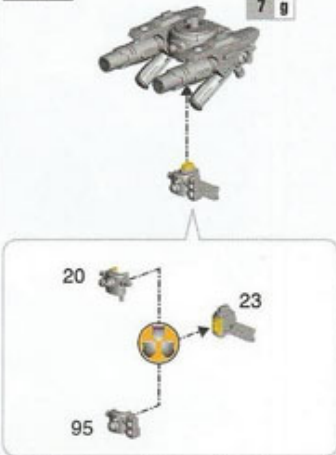

7 i

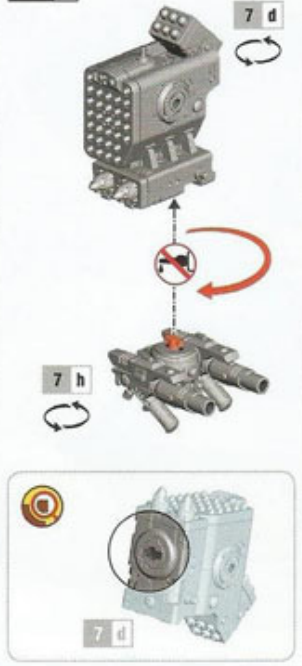

7 g



7 j



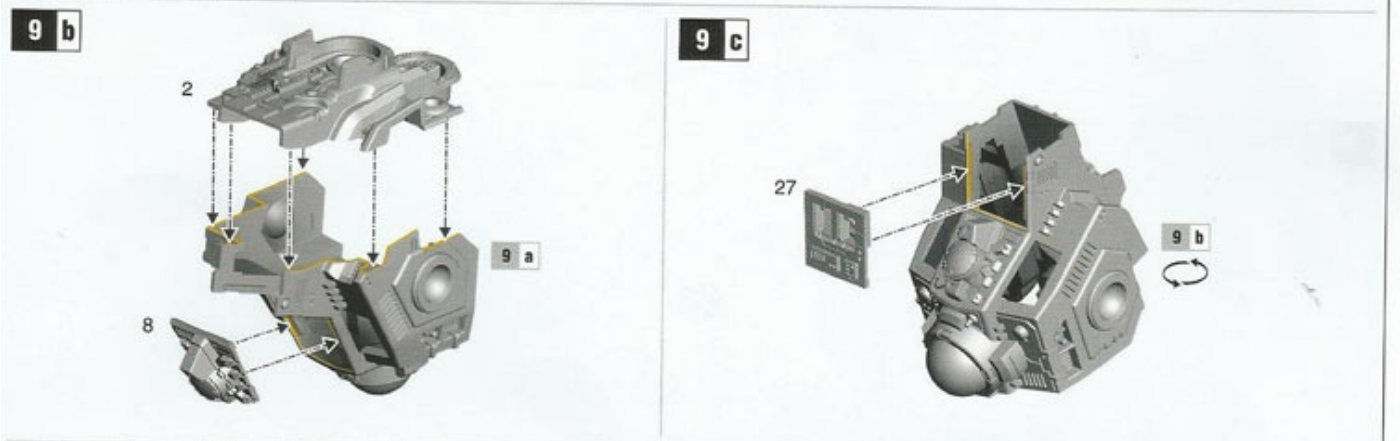
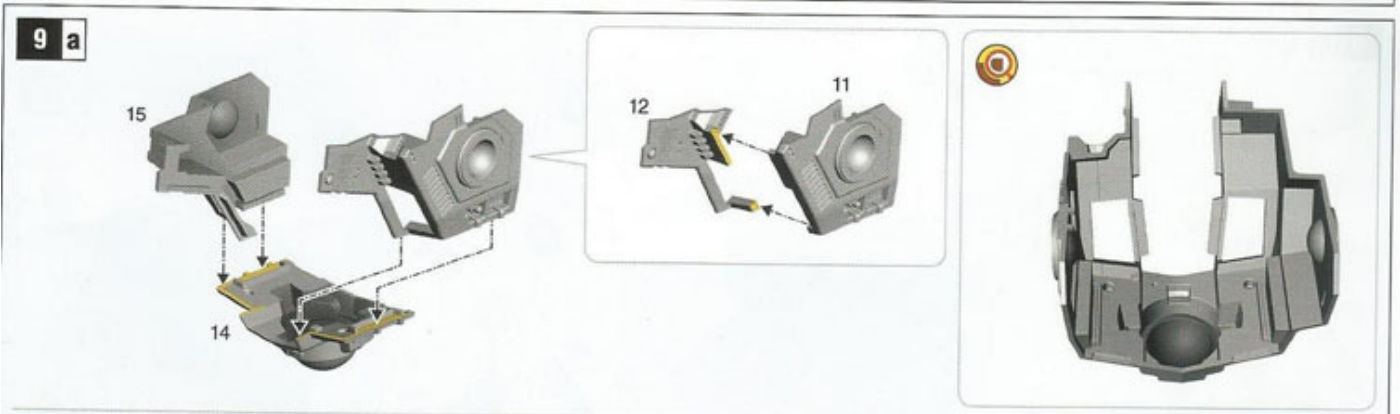
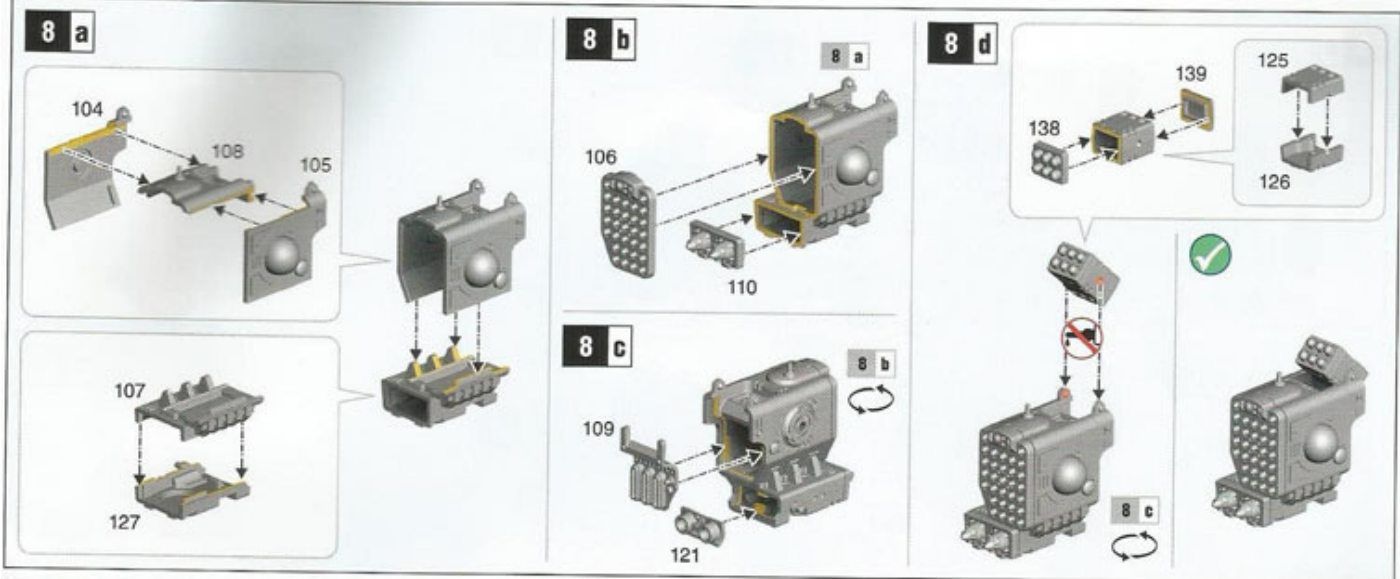

9 e

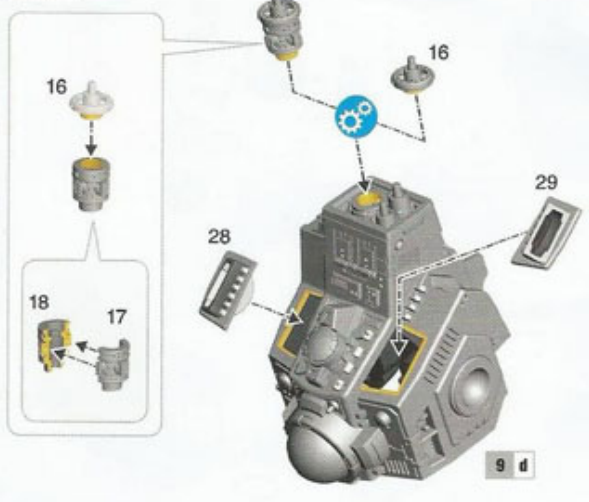

9 f

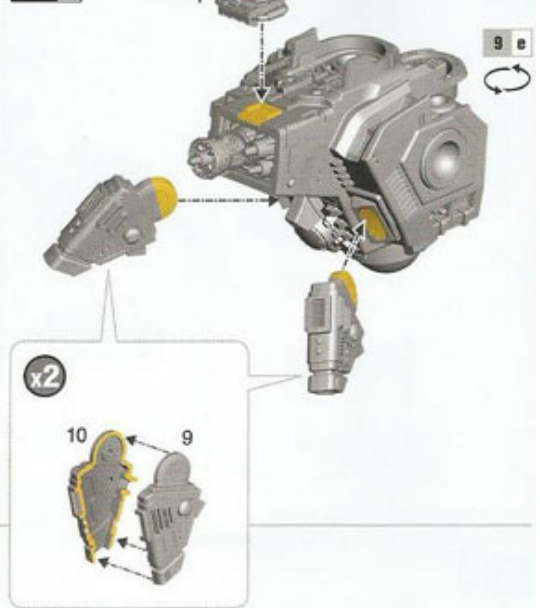

9 g

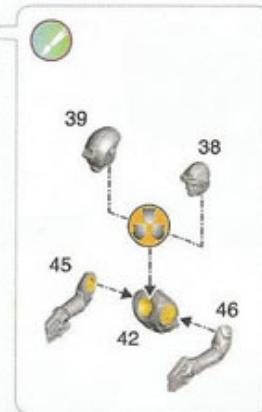
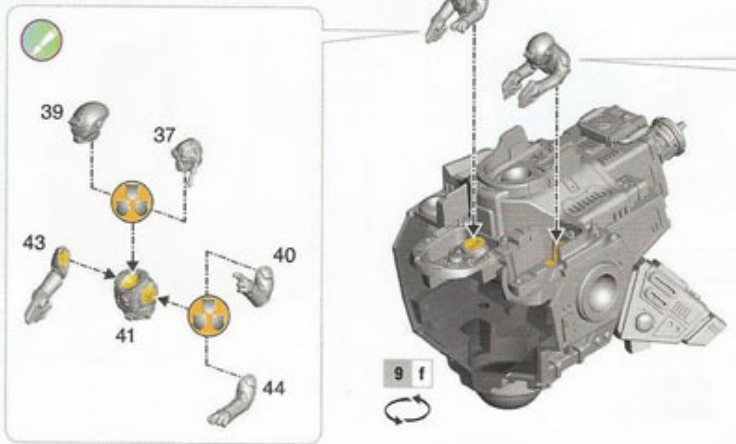

9 h

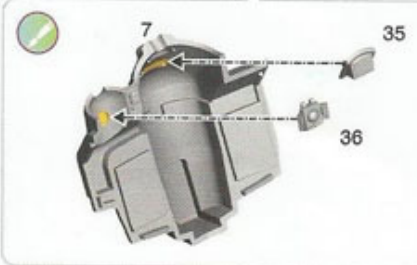
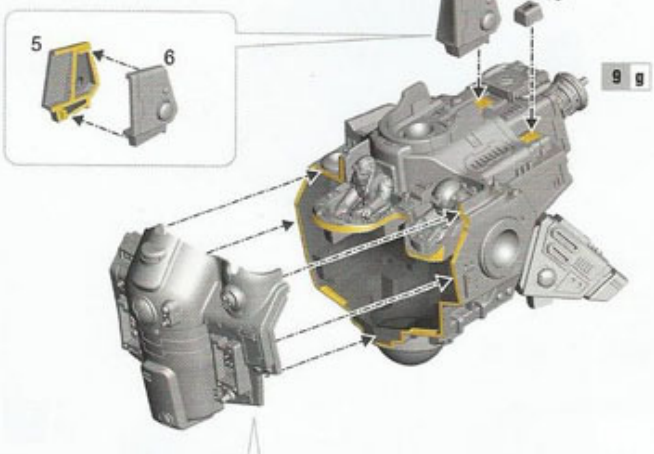



10



PULSE DRIVER CANNON

11



PULSE BLASTCANNON

10 a

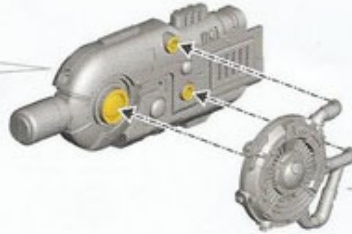

10 b x3

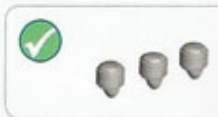

10 c

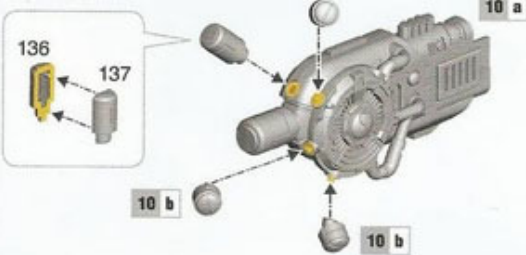

10 e

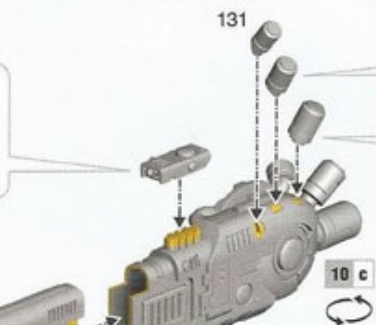
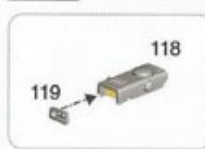

10 d

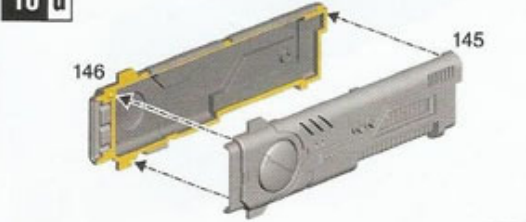

10 f

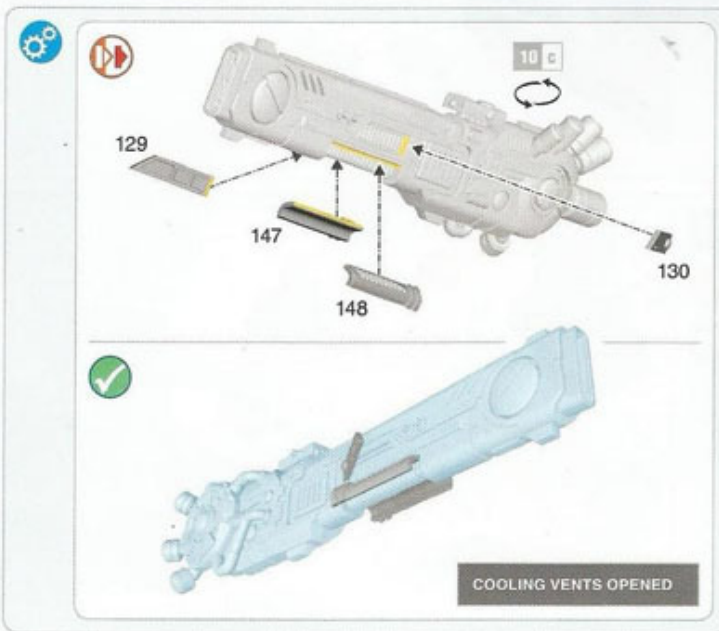
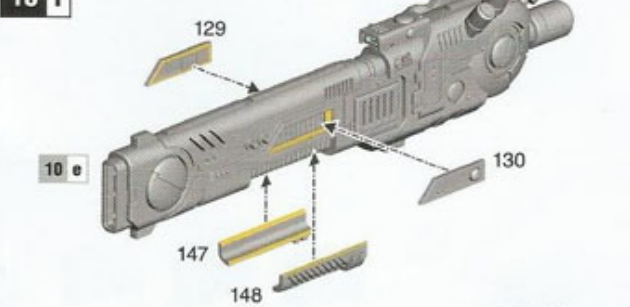

COOLING VENTS OPENED



11 a

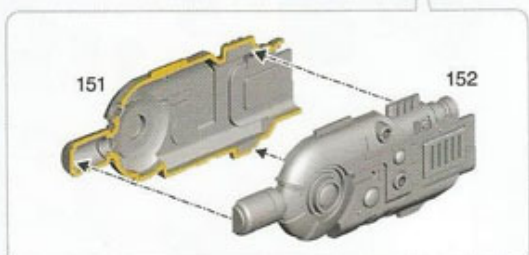
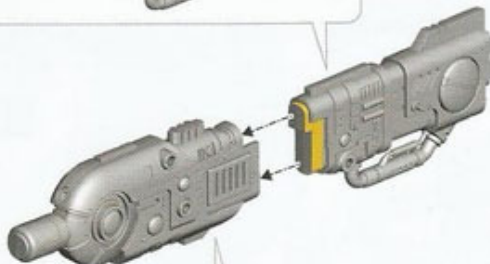
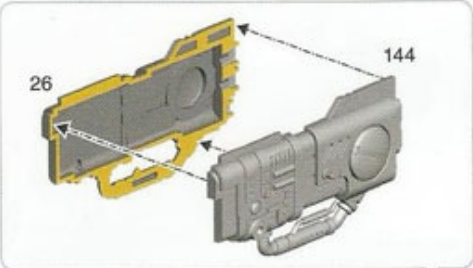

11 b

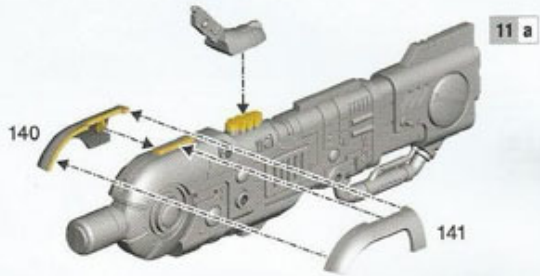

11 c

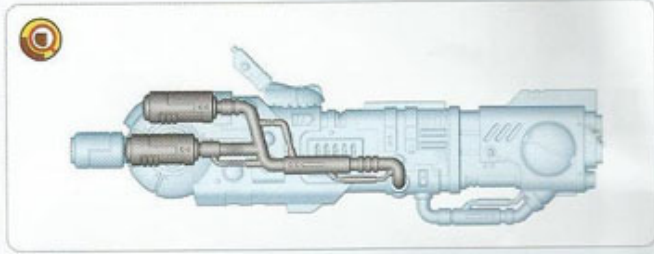
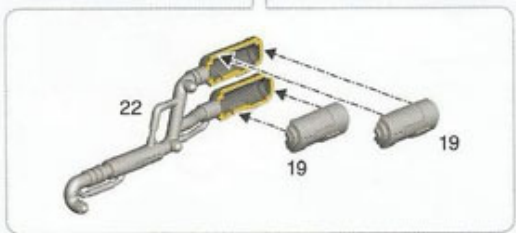
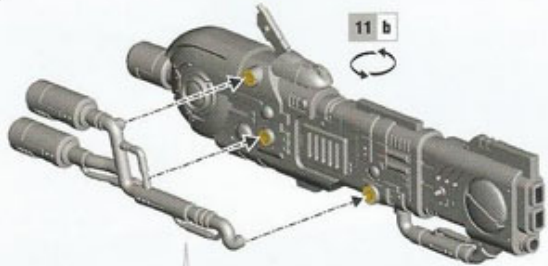

12

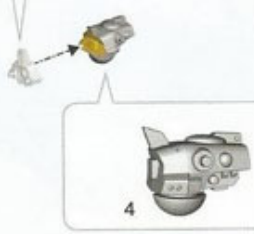



13 a

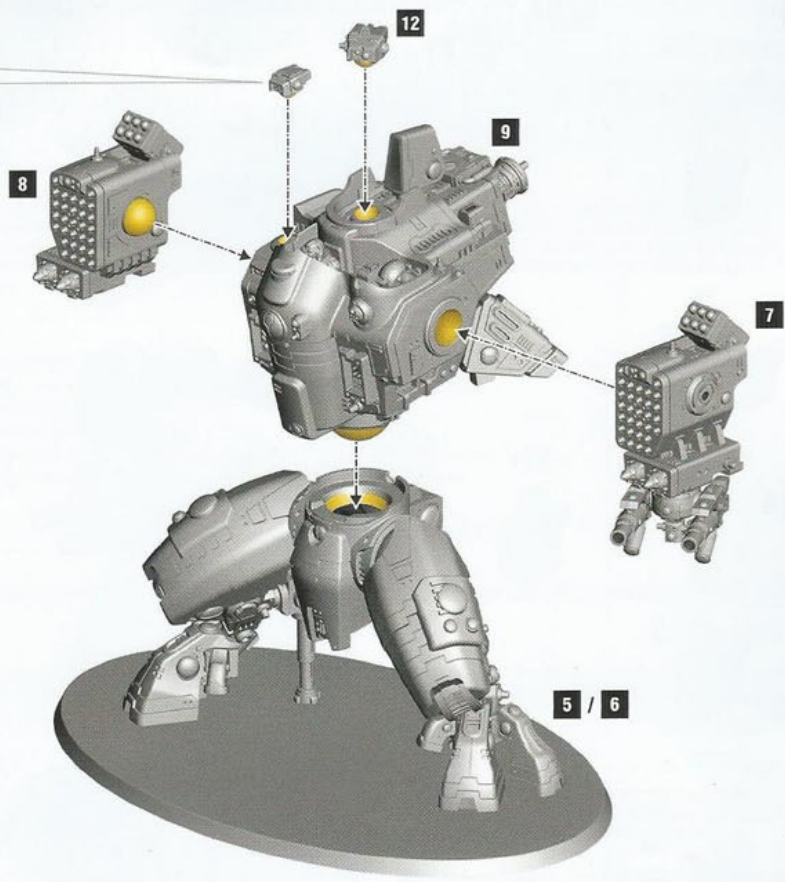

13 b

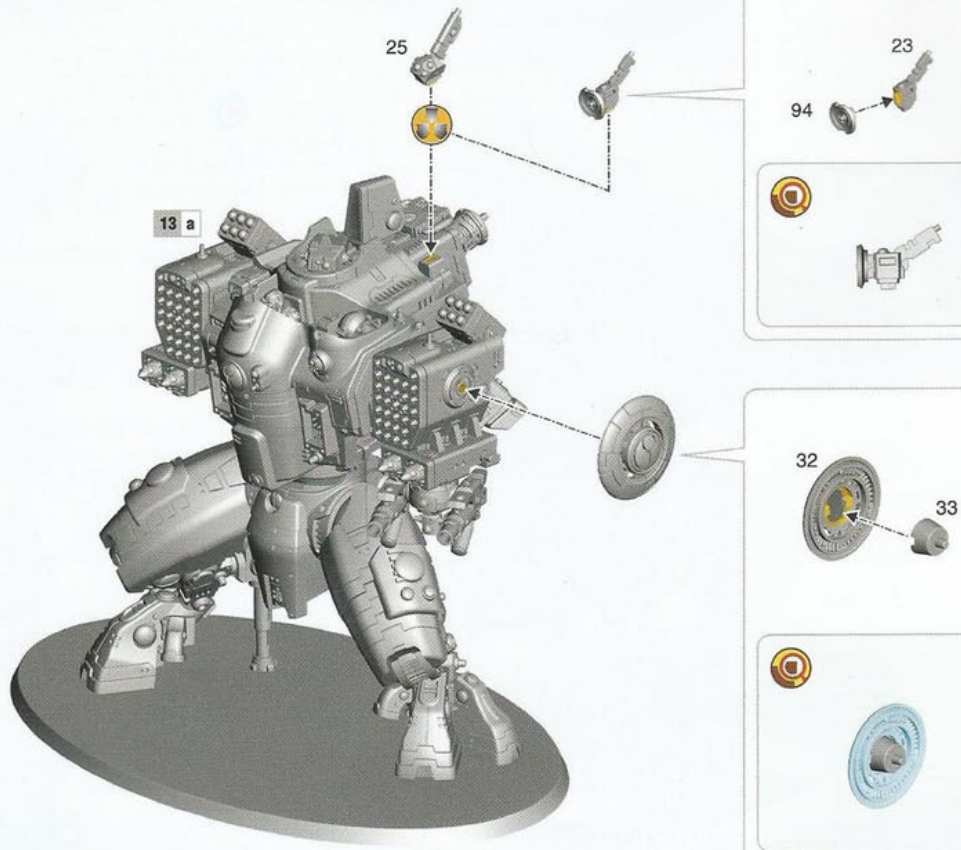

13 c



13 d



21



13 c

13 e

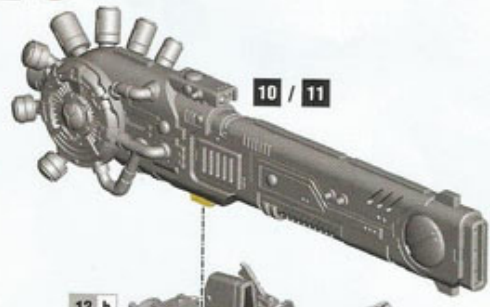

10 / 11

13 b



13 d



10 / 11



10



10



11

