

1

LEG CHASSIS ASSEMBLY • ASSEMBLAGE DU CHASSIS • MONTAGE DE LA PATA AL CHASIS
ZUSAMMENBAU DER BEINHALTERUNG • ASSEMBLAGGIO DEI SUPPORTI DELLE ZAMPE • 脚と胴体の組み立て

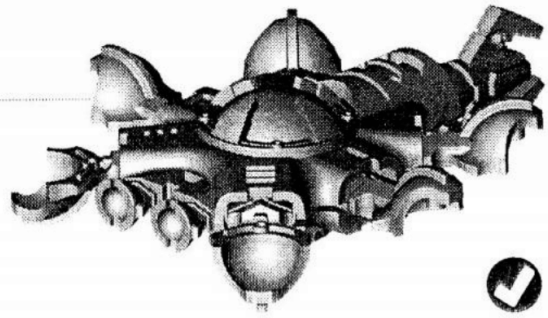
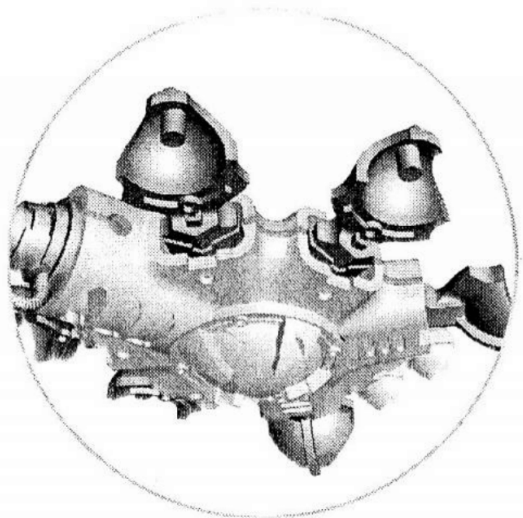
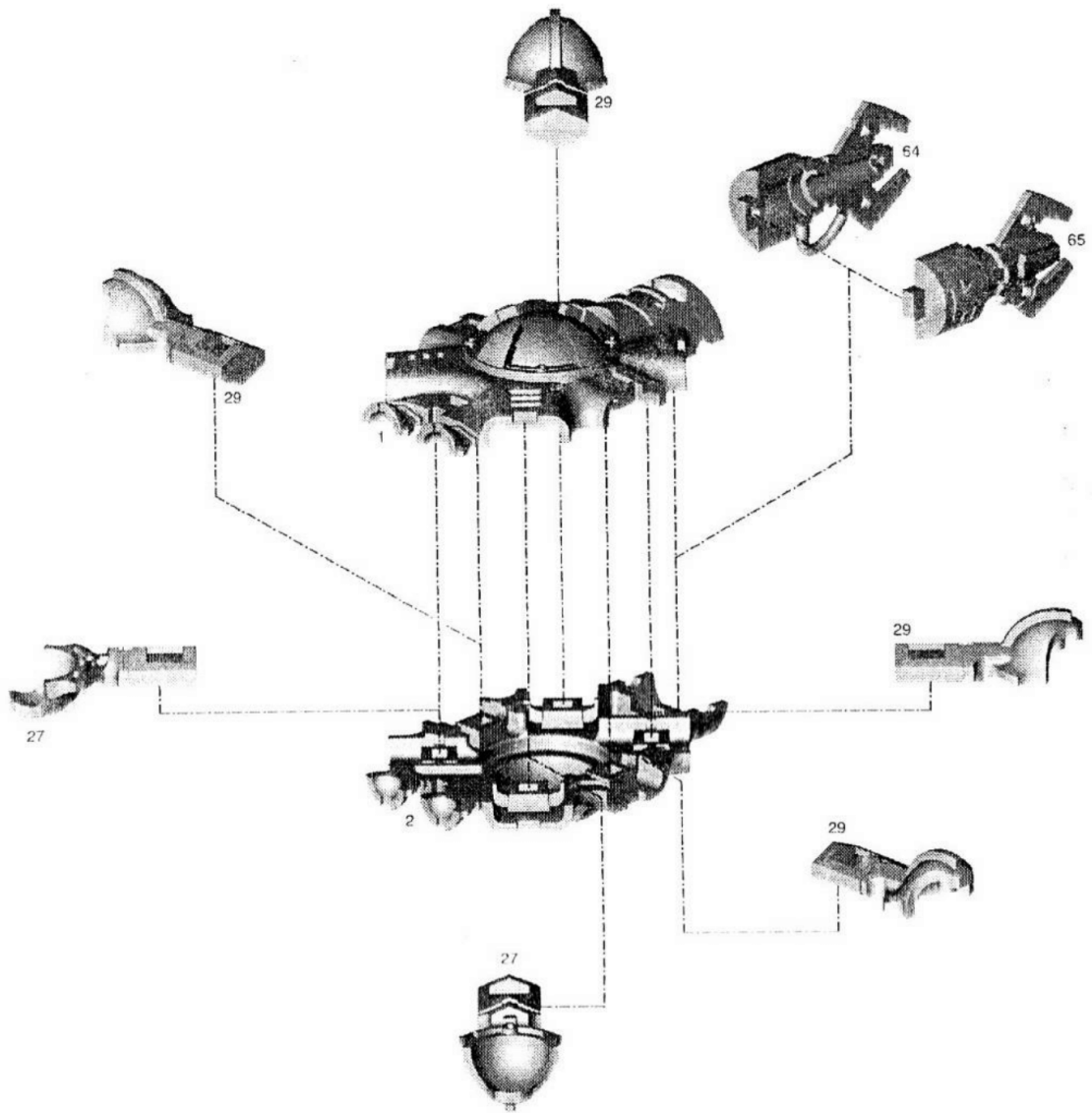

2

**LEGS ATTACHMENT • ASSEMBLAGE DES PATTES • SUJECIÓN DE LAS PATAS
ANBRINGEN DER BEINE • AGGIUNTA DELLE ZAMPE • 脚の取り付け**

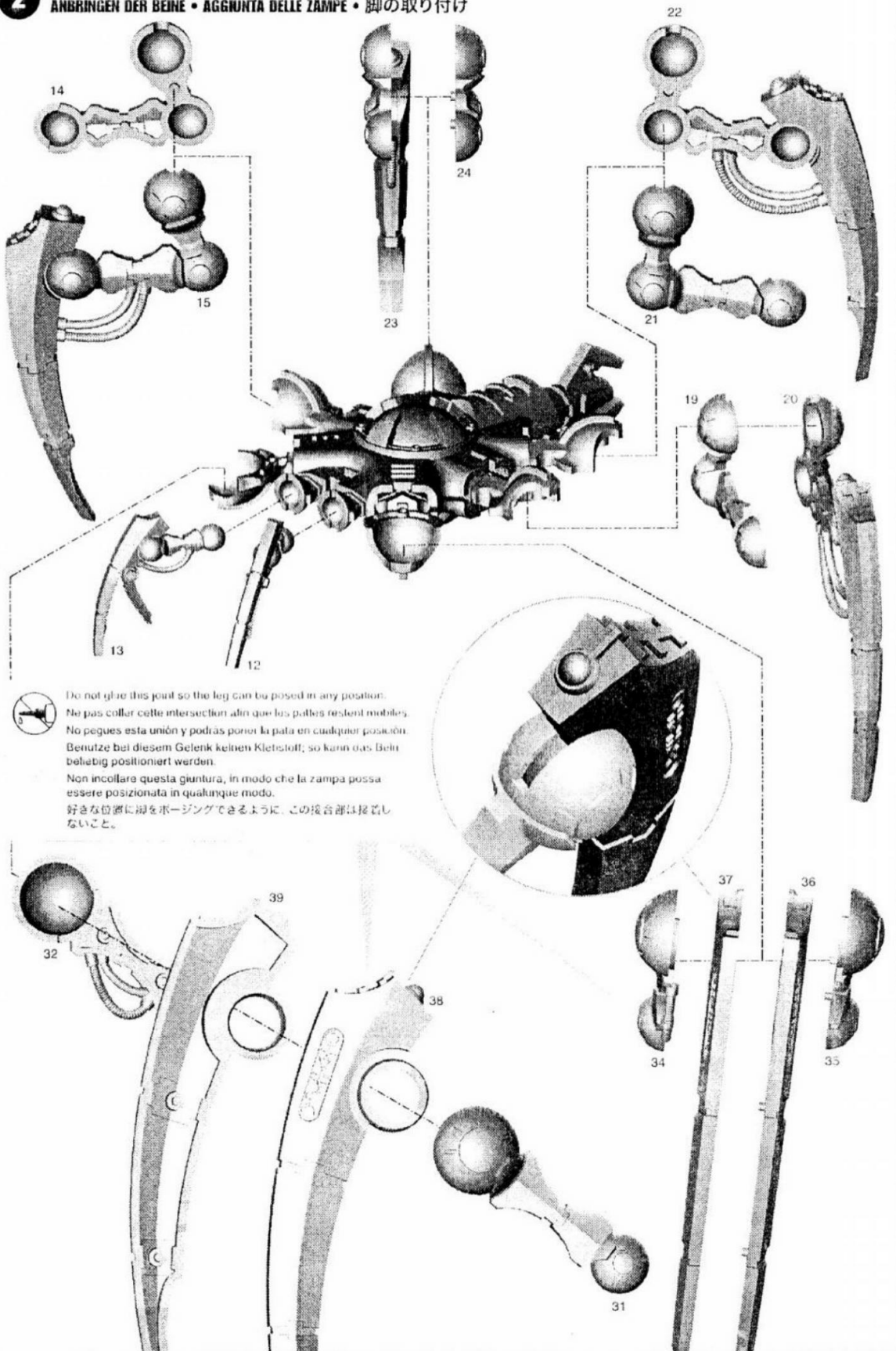

Do not glue this joint so the leg can be posed in any position.
 No pases coller cette intersection afin que les pattes restent mobiles.
 No pegues esta unión y podrás poner la pata en cualquier posición.
 Benutze bei diesem Gelenk keinen Klebstoff, so kann das Bein beliebig positioniert werden.
 Non incollare questa giuntura, in modo che la zampa possa essere posizionata in qualunque modo.
 好きな位置に脚をホーミングできるように、この接合部は接着しないこと。

3

COCKPIT ASSEMBLY • ASSEMBLAGE DU COCKPIT • MONTAGE DE LA CABINE
ZUSAMMENBAU DES COCKPITS • ASSEMBLAGGIO DELLA CARLINGA • コックピットの組み立て

A

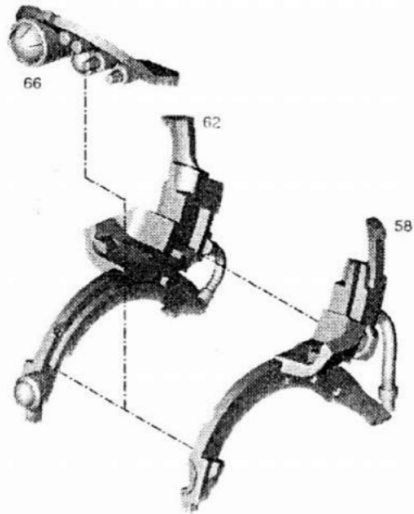

B

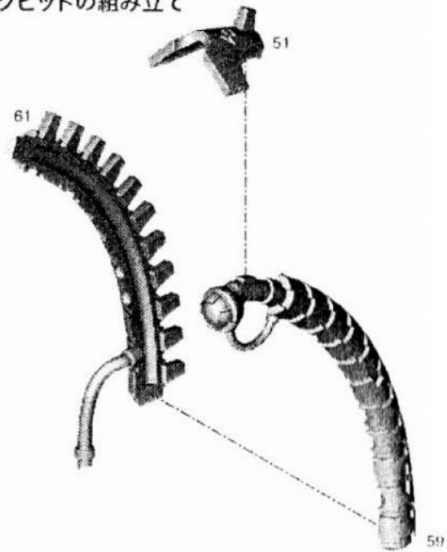

D

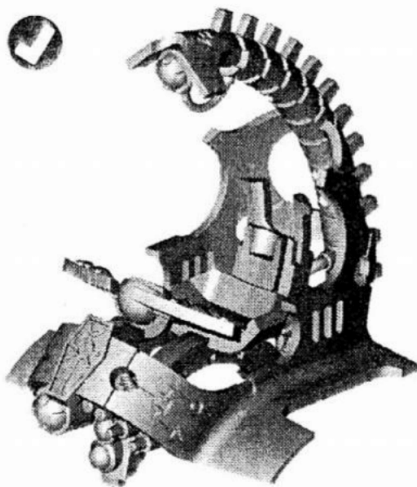

C

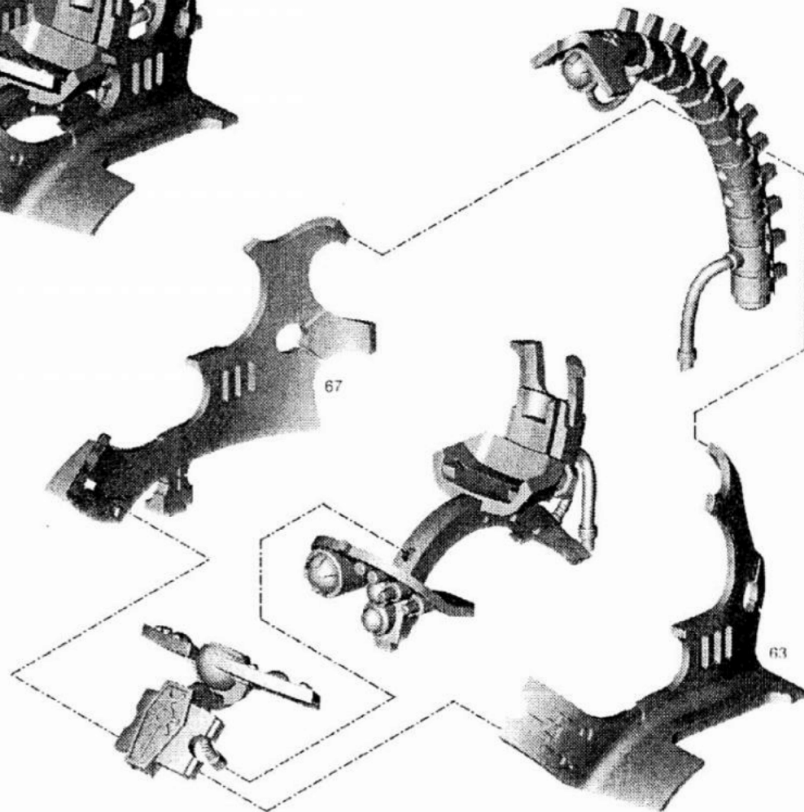
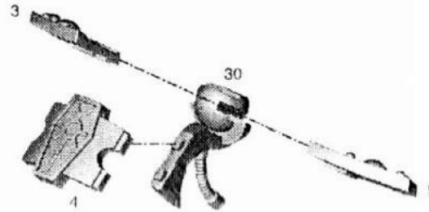

4 PILOT ASSEMBLY • ASSEMBLAGE DU PILOTE • MONTAJE DEL PILOTO
 ZUSAMMENBAU DES PILOTEN • ASSEMBLAGGIO DEL PILOTA • 操縦士の組み立て

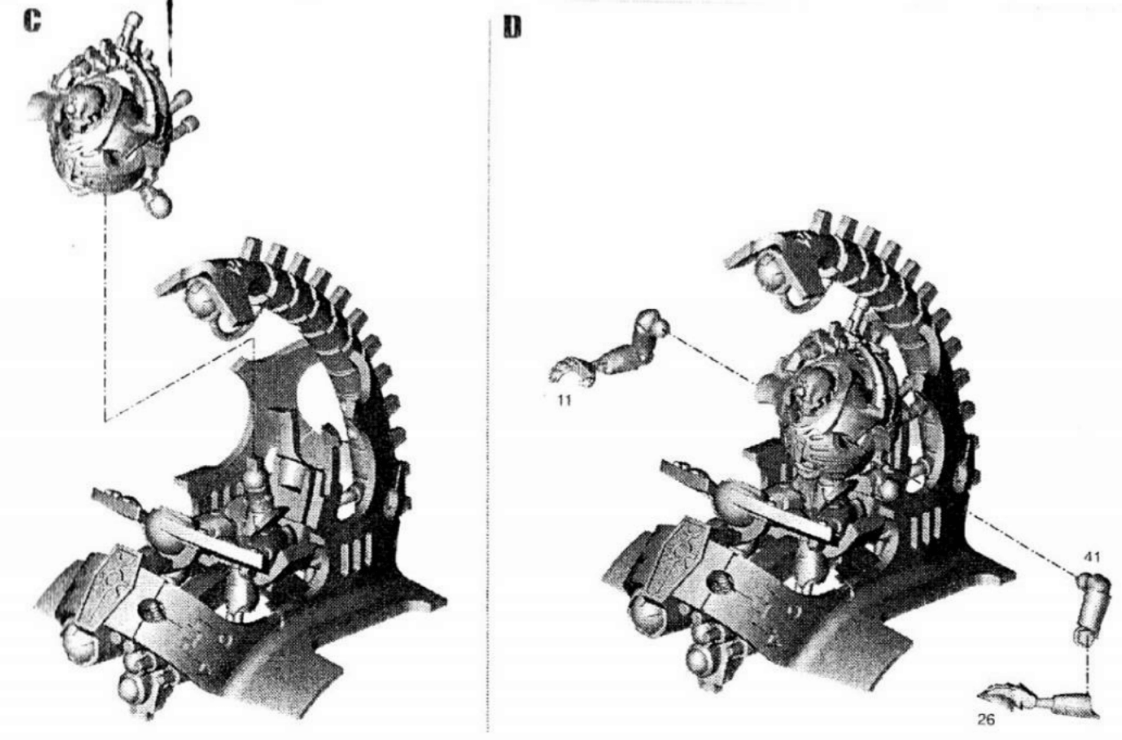
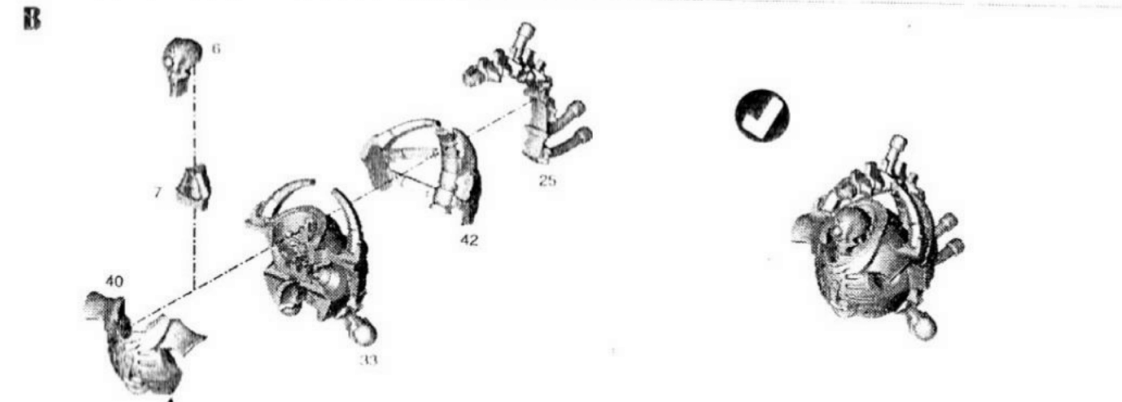
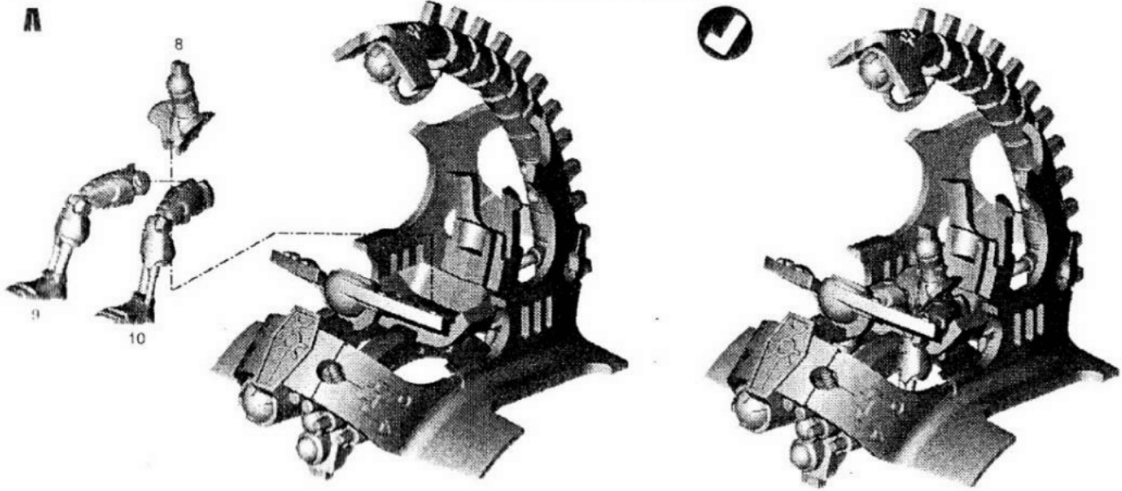

5 MAIN ASSEMBLY • ASSEMBLAGE PRINCIPAL • MONTAJE PRINCIPAL
HAUPTZUSAMMENBAU • ASSEMBLAGGIO PRINCIPALE • 主要部分の組み立て

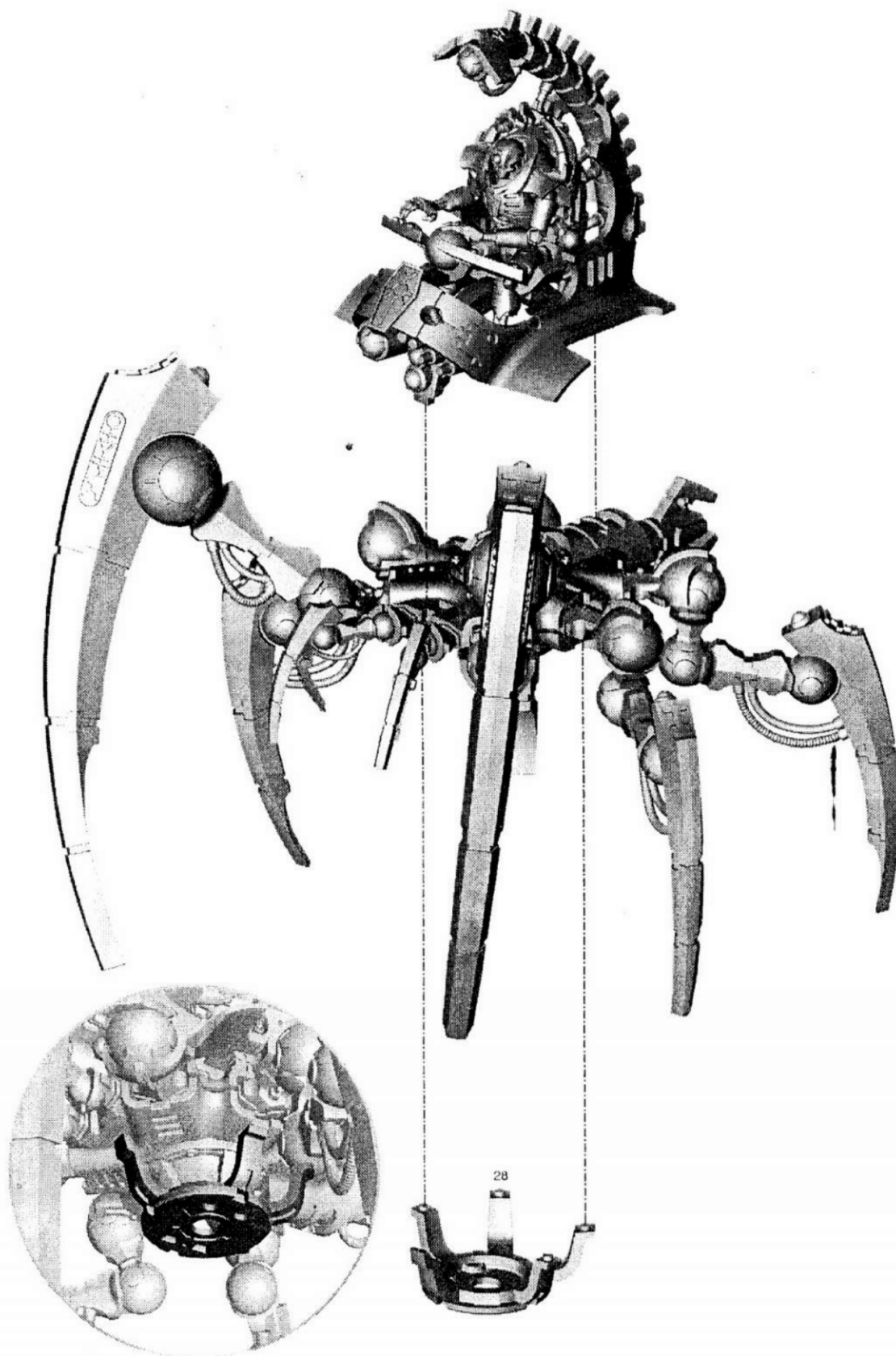

6 FINAL ASSEMBLY • ASSEMBLAGF FINAL • MONTAJE FINAL
ABSCHLIESSENDER ZUSAMMENBAU • ASSEMBLAGGIO FINALE • 最終組み立て

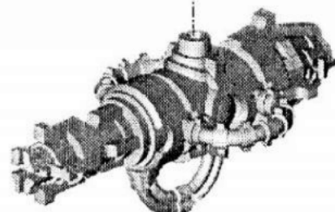
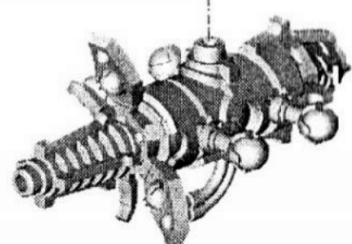
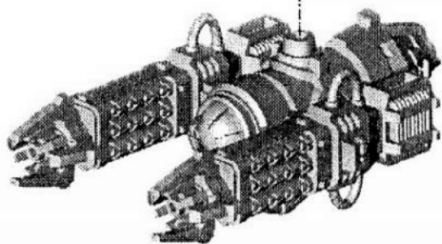
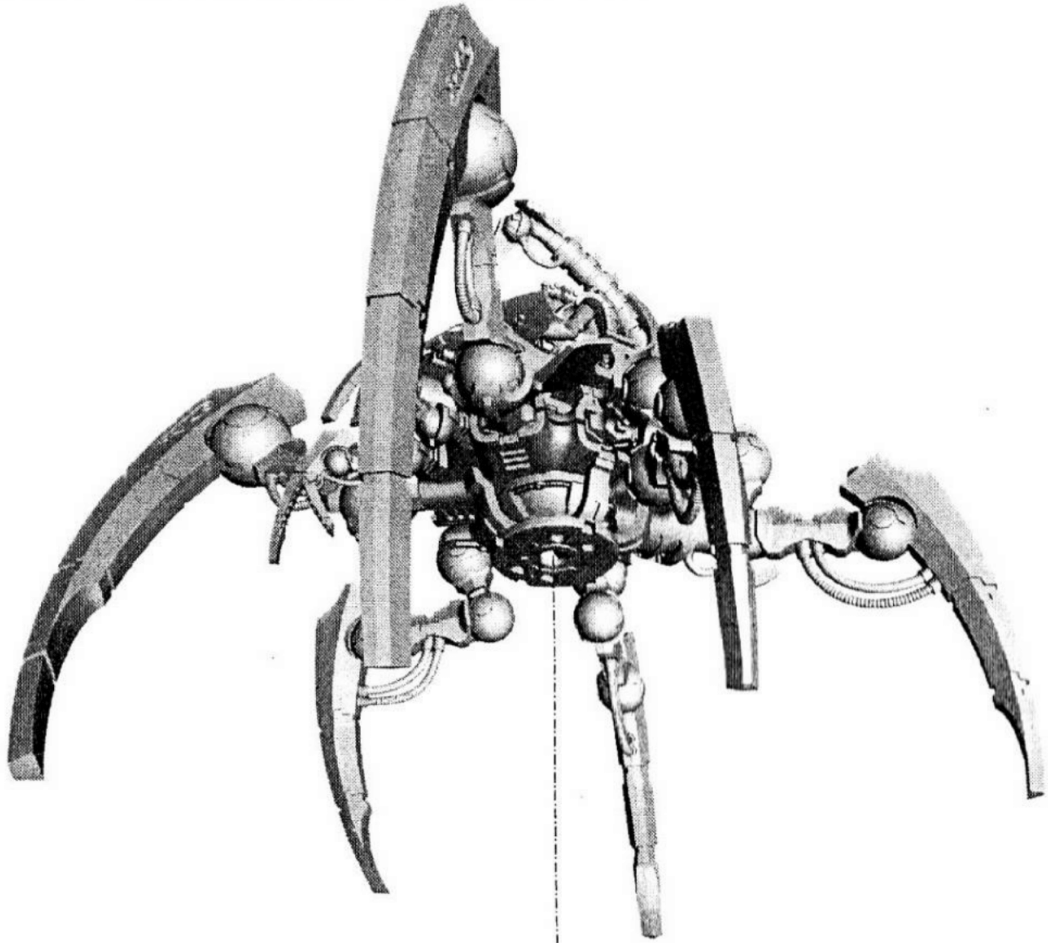

HEAT RAY
 RAYON INCENDIAIRE
 RAYO DE CALOR
 INTZESTRAHLER
 RAGGIO TERMICO
 ヒート・レイ

CHOOSE THE WEAPON FOR YOUR TRIARCH STALKER • CHOIX D'ARMES DU RÔDEUR DU TRIARCHAT
 ELIGE EL ARMA PARA TU ACECHANTE DE LA TRIARCA • WÄHLE DIE WAFFE DEINES JAGDLÄUFERS
 SCEGLI L'ARMA PER IL TUO CACCIATORE DEL TRIARCHATO • トライアーク・ストーカーの武装を択

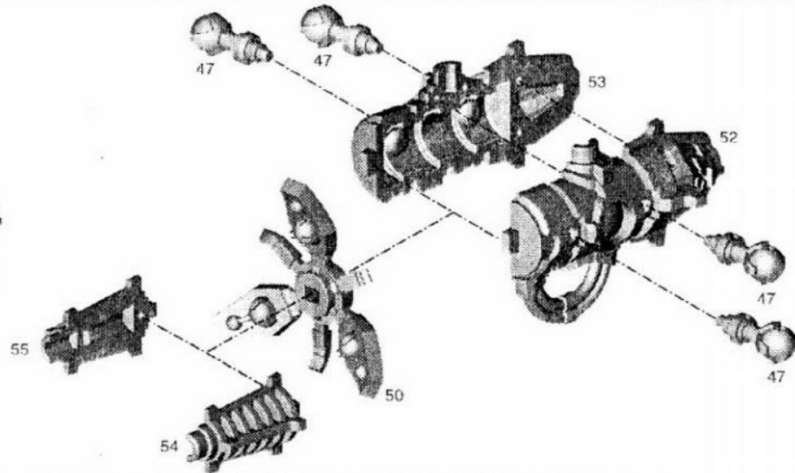
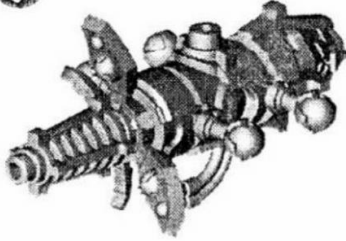

PARTICLE SHREDDER
 DÉCHIQUEUR À PARTICULES
 DESPEDAZADOR DE PARTICULAS
 PARTIKELKANONE
 STRAZIATORE FOTOIMCO
 パーティクル・シュレッダー

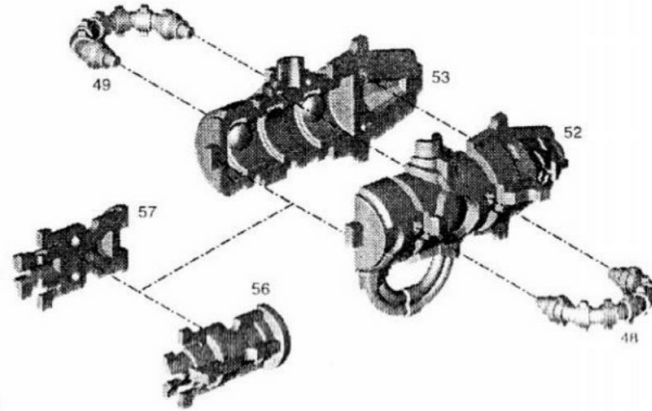
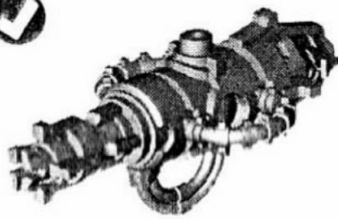

TWIN-LINKED HEAVY GAUSS CANNON • CANONS À FUSION LOURDS JUMELÉS • CAÑÓN PESADO GAUSS ACOPLADO
 SYNCHRONISIERTE SCHWERE GAUSS-KANONE • CANNONE PESANTE GAUSS BINATO • ツインリンク・ヘヴィガウス・キャノン

