

16 a

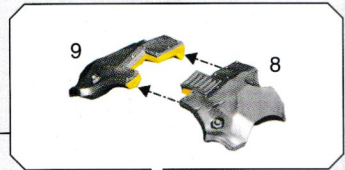

16 b

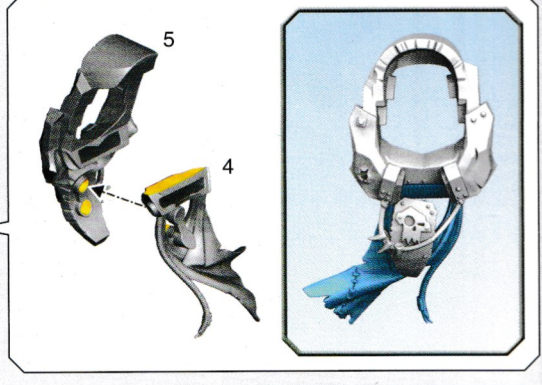
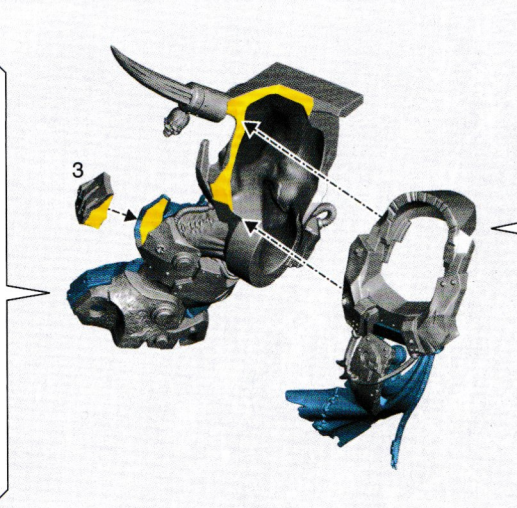
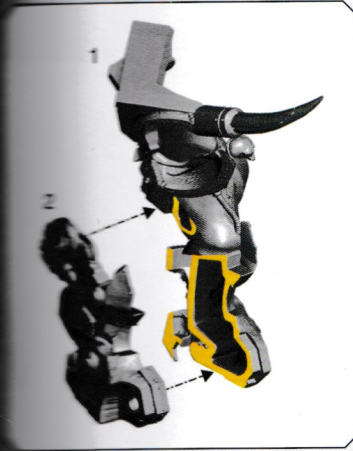
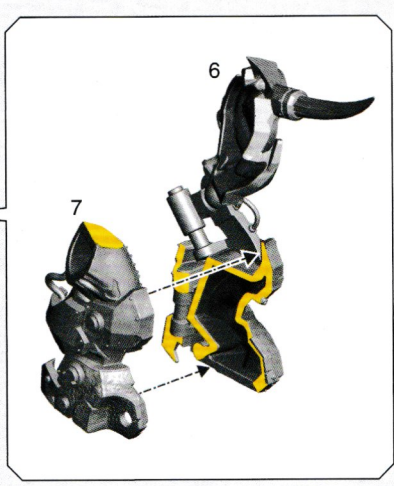
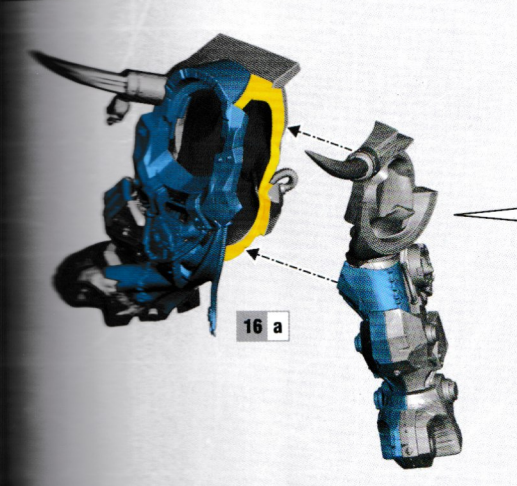

16 c

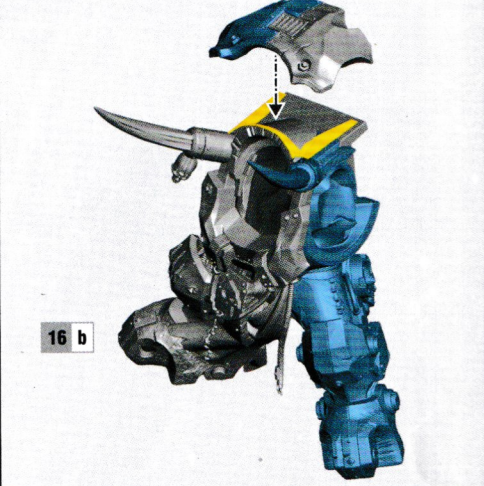

16 d

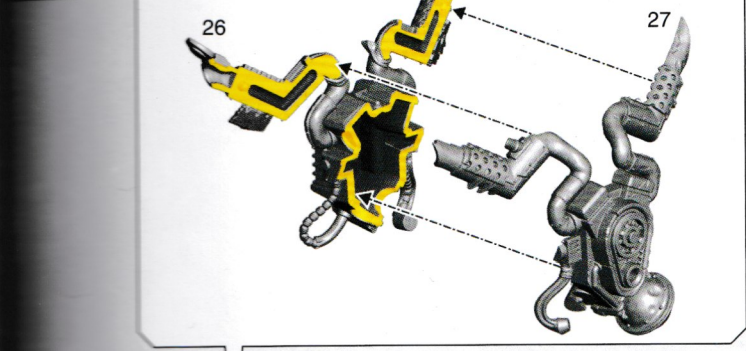

16 e

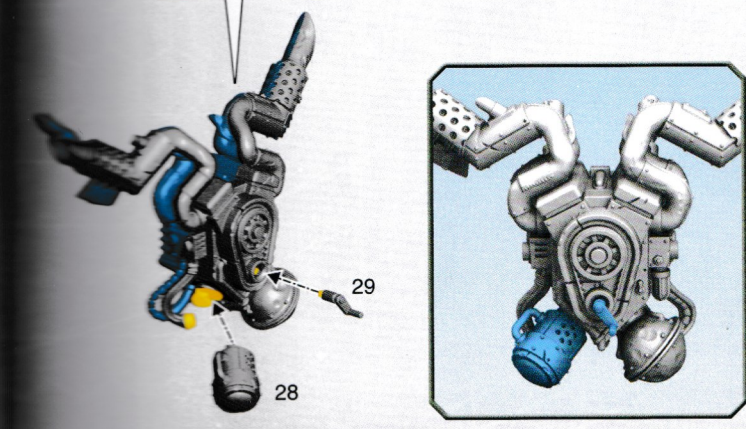
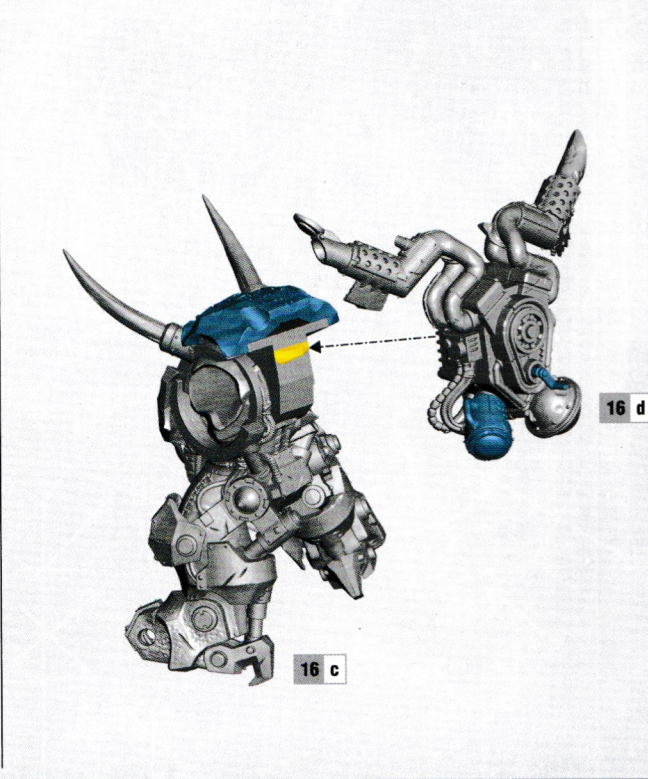

16 f

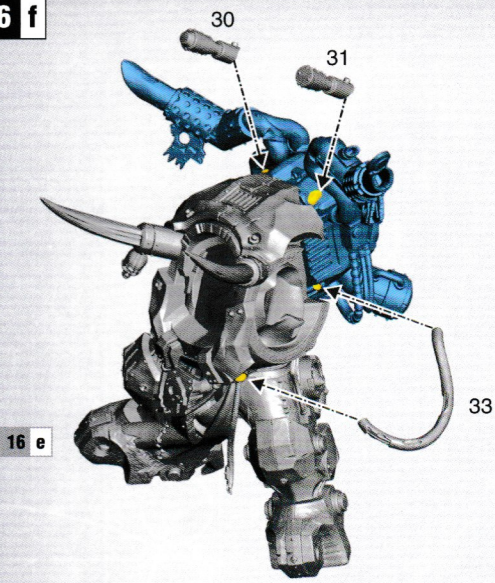

16 e

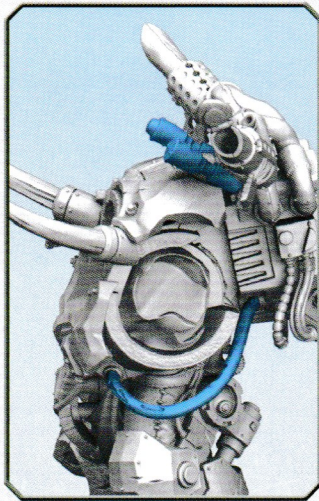

17 a

• Mork's Roar • Rugissement de Mork • Rugido de Mork • Morks Gebrüll • Ruggito di Mork • 摩克的咆哮 • モルクの怒鳴り

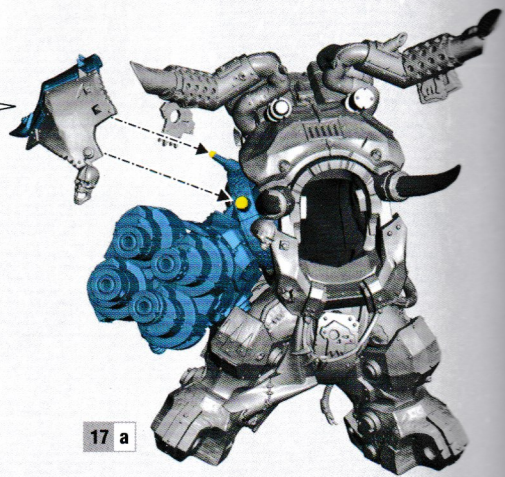
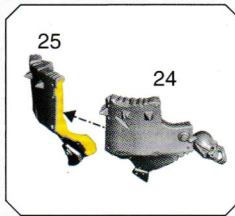
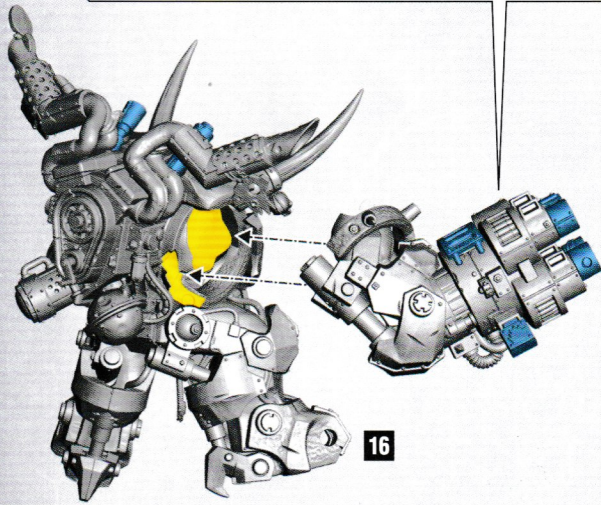
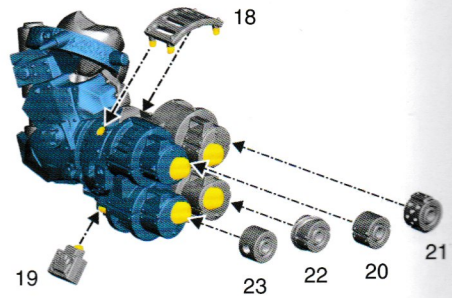
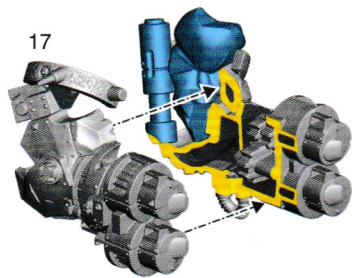
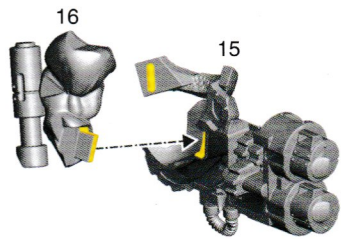

17 b

• Gork's Klaw • Griffes de Gork • Garra de Gork • Gorks Krallä
• Kela di Gork • 格克的利爪 • ゴルクのクロオ

17 c

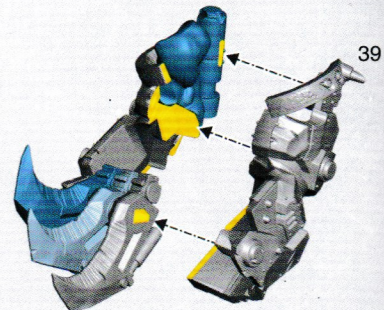
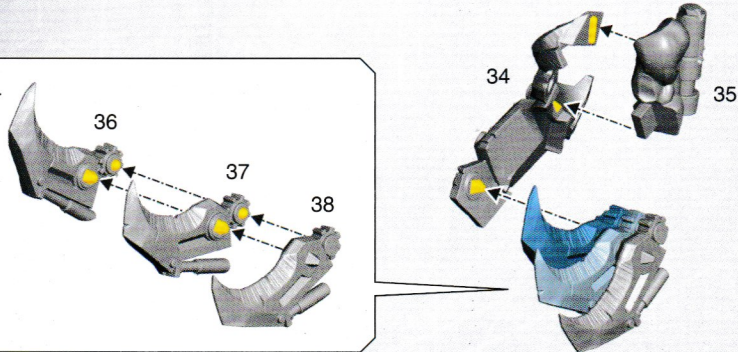

17 d

17 e

18



17 d

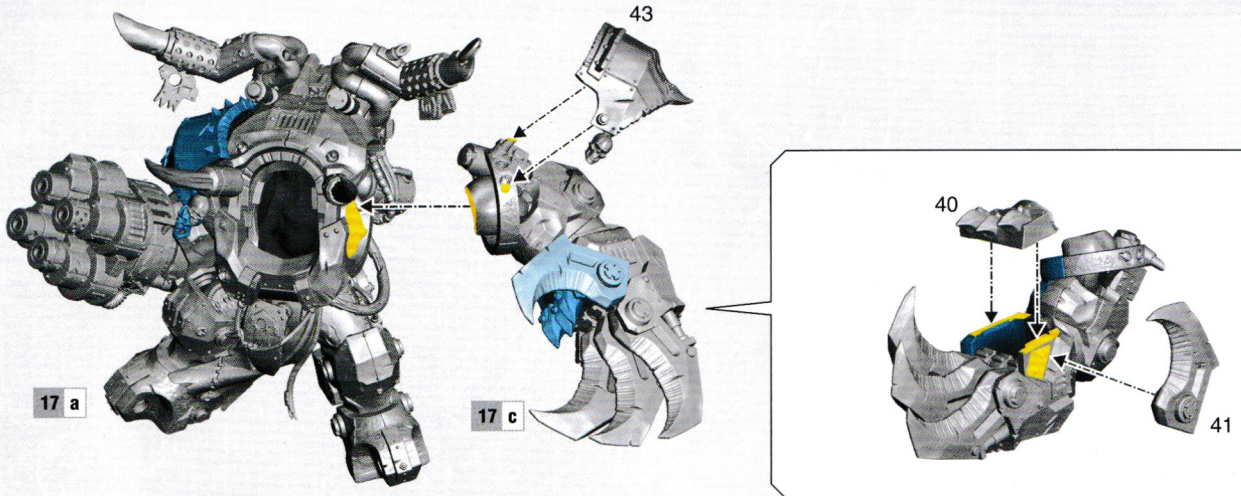

17 e

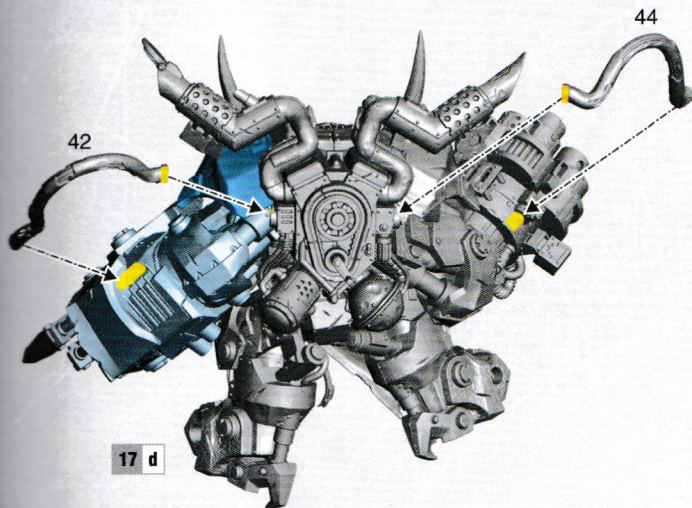

18 a



• Choose the variant you want to build • Choisissez la variante à assembler • Elige qué versión quieres montar
 • Wähle die Variante, die du bauen möchtest • Scegli la variante che vuoi assemblare • 选择你喜欢的拼装方式 • み立てバリエーションの



18 a 

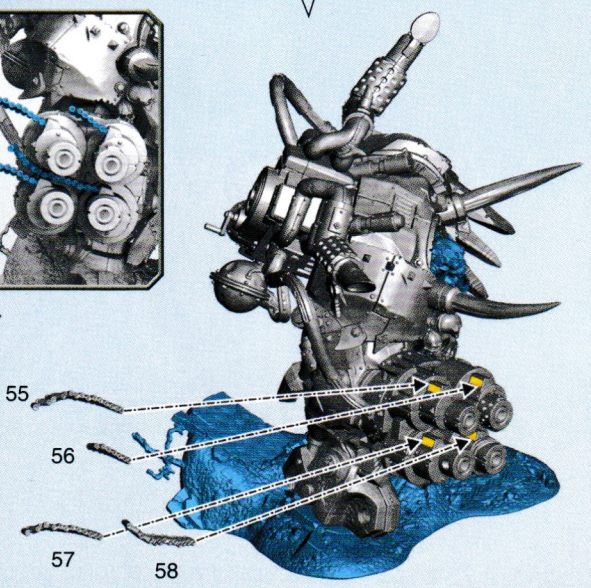
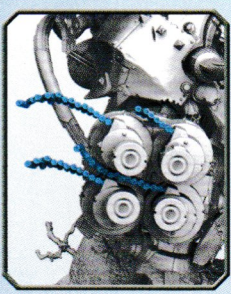
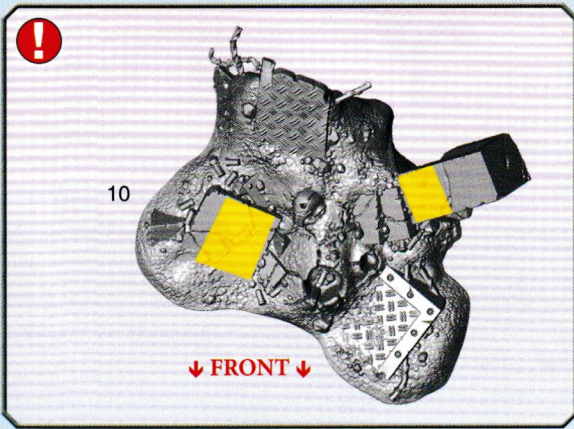
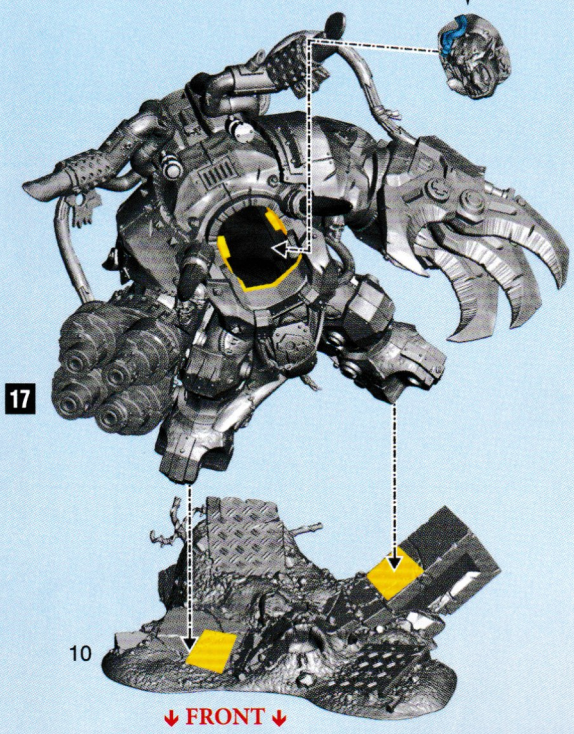
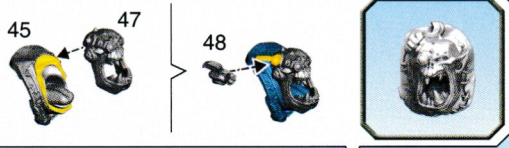

18 a 

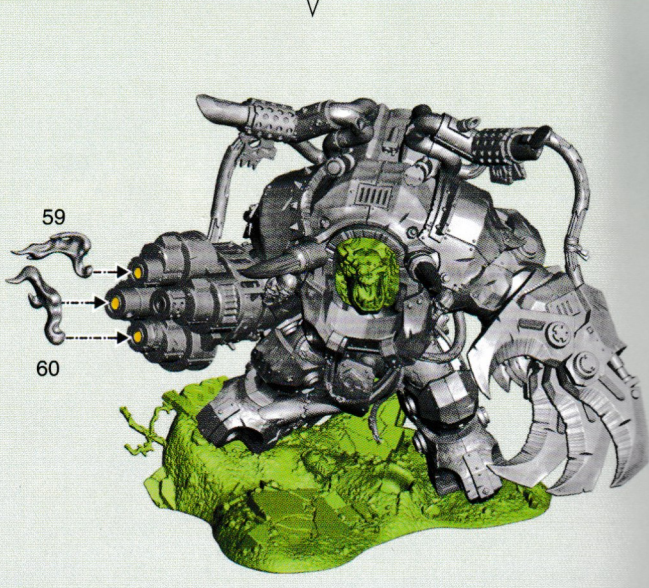
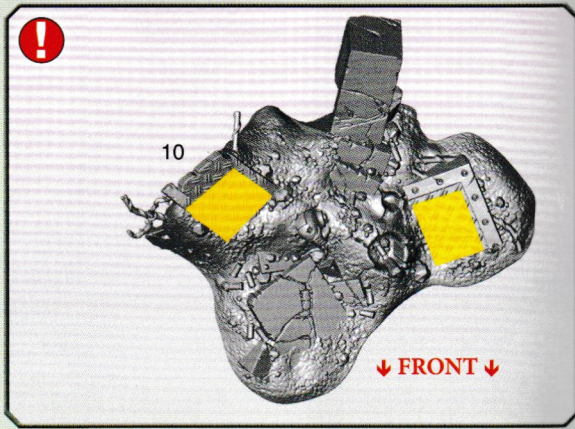
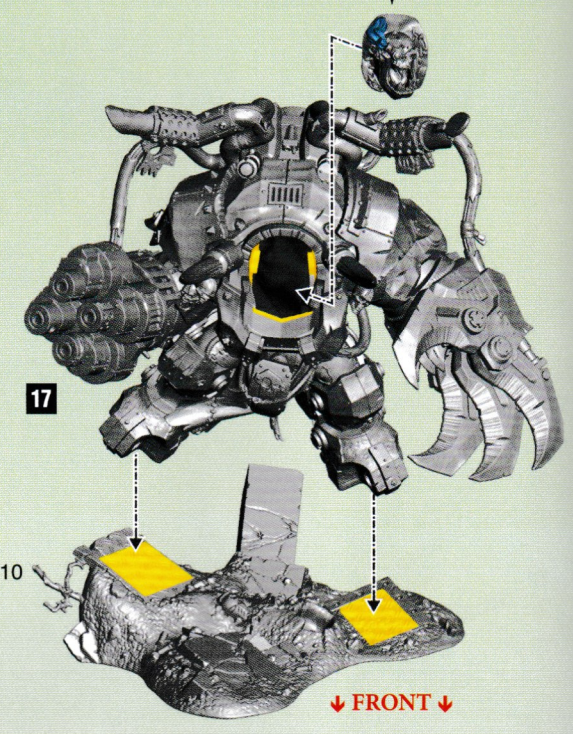
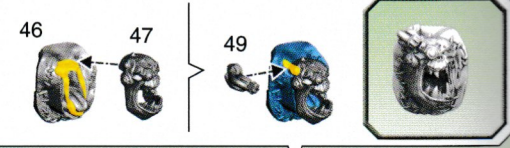

18 b

19 a

20 2

20 a 

